



Catalog 2016/2017

About Lensation

LENSATION provides free of charge consulting about lenses, illumination, optical components and Smart Cameras. In addition we offer a wide range of optical products.

We are fluent in English and German, but some of our people speak Korean, others Chinese or Japanese. As you can imagine, this opens doors in Asia. We can source asian products for you, be it optics or electronic parts.

Are you searching for products that you haven't been able to find yet? Ask us! What we can't offer you yet, we'll source for you. Name the product spec's and the target price - usually we can provide the desired product. And if 'your' product really isn't available, we'll design it for you! Exclusive OEM designs are possible, or just job order production. We care about your individual constraints such as product spec's, high quality and good prices.



Our mission is to keep our customers excited.

With this goal in mind, we provide:

- Free consultancy.
- Exceptionally good value for money.
- Best performance.
- OEM design and development.
- Unique solutions.
- Products tailored especially according to your demands.

Lensation GmbH
 Unterer Dammweg 12
 76149 Karlsruhe/Germany

Tel: +49 721 75 40 45-0
 Fax: +49 721 6054 339-3

Email: info@lensation.de
www.lensation.de

S-Mount Lenses

10+ Megapixel Board Lenses	4
5 Megapixel Board Lenses	4
3 Megapixel Board Lenses	5
1-2 Megapixel Board Lenses	6
VGA & High Resolution Board Lenses	7
Waterproof Automotive Board Lenses	8
Fisheye Board Lenses	8
Pinhole Board Lenses	9
Light Sensitive Board Lenses	9
High Speed Board Lenses	10

C-Mount (FA) Lenses

8 Megapixel C-Mount Lenses	11
5 Megapixel High Resolution Machine Vision	12
Megapixel C-Mount Lenses (C3M series)	13
Megapixel Low Distortion CCTV Lenses	13
Megapixel High Resolution CCTV Lenses	14
High Quality C-Mount Lenses	14
High Speed F0.95 C-Mount Lenses	15
Megapixel Low Distortion Varifocal Lenses	15
Fisheye C-Mount Lenses	15
Economy Megapixel C-Mount Lenses	16

Accessories

	17
--	----

Telecentric Lenses

Double Side Telecentric Lenses	
T29M, T4M and TDC Series	18
Object Side Telecentric Lenses	
T25M and T15M Series	19
TF8M Series: 8 Megapixel Telecentric	20
TC4M Series: 4 Megapixel Telecentric	21
TC5M Series: 5 MP, Ultra High Resolution	22-23
TCHR Series: High Resolution Telecentric	24-25
TCST Series: Standard Telecentric	26-29
Telecentric Zoom Lenses	30
Sensor Size Extender	30

Line Scan Lenses

TL4K Series: Telecentric Line Scan Lenses	31
TL8K/TL12K Series: Telecentric Line Scan Lenses	32
Line Scan Lenses for Wide Filed of View	33
Line Scan Lenses for 8K to 12K line CCD	34

Macro Lenses

Macro Zoom Lenses	35
MCV5M Varifocal Macro Zoom Lens	36
Macro Lenses up to 15 Megapixels	37-38

Illumination

Coaxial LED Illumination	39
Analog LED Controller	40
Digital LED Controller	40

Optics Glossary	41
Optics Formulas	42-43

S-Mount

C-Mount

Accessories

Telecentric

Line Scan

Macro

Illumination

S-Mount Lenses (M12x0.5)

S-Mount Lenses (M12x0.5)

10+ Megapixel Board Lenses



Lensagon No.	Image format	Focal length	Aperture	M.O.D.	Back focal length	FOV (dia.)	Weight	IR corr.	IR cut Option	Megapixel	Distortion	Lensagon No. with IR cut
NEW B14M28620S123C	1/2.3"	2.86	2.0	0.1m	5.71	170°	15.0g		only	14	-0.2%	
NEW B10M45545ND	1/2.3"	4.55	4.5	0.1m	3.44	81.7°	8.2g		•	10	<0.5%	B10M45545NDC
B10M5022S12	1/2"	5.0	2.2	0.3m	8.5	94°	11.0g	•	•	10		B10M5022S12C
B10M5425	1/2.3"	5.4	2.5	0.2m	6.6	70°	6.0g	•	•	10		B10M5425C
B10M7224	1/2.3"	7.2	2.4	0.3m	7.23	57°	12.6g	•	•	10		B10M7224C
NEW B14M20020S123C	1/2.3"	20	2.0	0.2m	13.43	21.5°	6.0g		only	14		

5 Megapixel Board Lenses



Lensagon No.	Image format	Focal length	Aperture	M.O.D.	Back focal length	FOV (dia.)	Weight	IR corr.	IR cut Option	Megapixel	Distortion	Lensagon No. with IR cut
B5M2524	1/2.5"	2.5	2.4	0.1m	4.98	166°	6.1g		•	5		B5M2524C
B5M2916	1/2.5"	2.9	1.6	0.1m	4.47	152°	7.2g	•	•	5		B5M2916C
B5M29740ND	1/2.5"	2.97	4.0	0.2m	2.97	102°	3.5g		•	5	< 1%	B5M29740NDC
B5M3618	1/2.5"	3.6	1.8	0.2m	7.25	128°	5.0g		•	5		B5M3618C
B5M4018	1/2.5"	4.0	1.8	0.2m	7.72	112°	5.0g		•	5		B5M4018C
B5M41430ND	1/2.5"	4.14	3.0	0.2m	5.25	82°	8.3g		•	5	< 0.2%	B5M41430NDC
B5M6018	1/2.5"	6.0	1.8	0.2m	9.58	75°	6.5g		•	5		B5M6018C
B5M7630	1/1.8"	7.6	3.0	0.2m	5.38	58°	7.0g		•	5		B5M7630C
B5M8018	1/2.5"	8.0	1.8	0.2m	7.8	56°	6.5g		•	5		B5M8018C
B5M8430N	1/1.8"	8.4	3.0	0.2m	2.79	60°	6.9g		•	5		B5M8430NC
NEW B5M12020	1/2.5"	12.0	2.0	0.3m	7.6	35°	5.0g	•	•	5		B5M12020C
B5M12028	1/1.8"	12.0	2.8	0.1m	8.57	41°	7.0g		•	5		B5M12028C
B5M12056	1/1.8"	12.0	5.6	0.1m	8.57	41°	7.0g		•	5		B5M12056C
NEW B5M16020	1/2"	16.0	2.0	0.3m	7.1	28°	5.0g	•	•	5		B5M16020C
NEW B5M25024	1/2"	25.0	2.4	0.3m	11.98	18.8°	5.0g	•	•	5		B5M25020C

3 Megapixel Board Lenses



Lensagon No.	Image format	Focal length	Aperture	M.O.D.	Back focal length	FOV (dia.)	Weight	IR corr.	IR cut Option	Megapixel	Distortion	Lensagon No. with IR cut
NEW B3M21835ND	1/4"	2.18	3.5	0.1m	1.30	94°	4.0g		•	3	<0.6%	B3M21835NDC
B3M2818	1/2.5"	2.8	2.2	0.3m	5.8	147°	5.0g	•	•	3		B3M2818C
BM3516ND	1/3"	3.5	1.6	0.2m	5.97	81°	10.0g	•	•	3	< 1.9%	BM3516NDC
BM3518S125ND	1/2.5"	3.5	1.8	0.2m	5.97	90°	12.0g	•	•	3	< 1.9%	BM3518S125NDC
NEW BM3524S12ND	1/2"	3.5	2.4	0.1m	6.09	97°	21.8g	•	•	3	<-3.1%	BM3524S12NDC
B3M3616	1/2.5"	3.6	2.0	0.2m	6.0	120°	6.3g	•	•	3		B3M3616C
B3M4016	1/2.5"	4.0	2.2	0.2m	7.28	112°	5.4g	•	•	3		B3M4016C
BM4018S118	1/1.8"	4.0	1.8	0.2m	8.0	126°	10.0g	•	•	3		BM4018S118C
BM4516ND	1/3"	4.5	1.6	0.2m	6.1	68°	10.0g	•		3	< 1.9%	BM4516C
BM4518S125ND	1/2.5"	4.5	1.8	0.2m	6.14	76.4°	13.0g	•	•	3	< 1.9%	BM4518S125NDC
NEW BM4518S118ND-810	1/1.8"	4.5	1.8	0.1m	6.4	90°	14.0g	•		3	<2.8%	
BM5518S12ND	1/1.8"	5.5	1.8	0.2m	6.87	76°	10.0g	•		2	< 1.9%	BM5518S12NDC
NEW BM6020ND	1/3"	6.0	2.0	0.2m	6.27	57°	5.9g	•	•	3	<-2.6%	BM6020C
B3M6016	1/2.5"	6.0	2.2	0.3m	6.8	72°	5.8g	•	•	3		B3M6016C
B3M6020S12	1/2"	6.0	2.0	0.5m	8.3	81°	9.9g			3		
B3M8016	1/2.5"	8.0	2.2	0.4m	8.0	54°	5.0g	•	•	3		B3M8016C
B3M8018S12	1/2"	8.0	1.8	0.5m	7.9	57.7°	10.7g			3		
BM8018S118NDV2	1/1.8"	7.8	1.8	0.1m	7.1	57°	36.1g	•	•	3	-2.0%	BM8018S118NDV2C
B3M12016	1/2"	12.0	2.3	0.3m	6.44	35°	5.0g	•	•	3		B3M12016C
B3M16018	1/2"	16.0	1.8	0.35m	7.21	27.8°	6.5g	•	•	3		B3M16018C
B3M25024	1/2"	25.0	2.4	0.4m	10.26	18°	7.1g	•	•	3		B3M25024C
B3M35025	1/2"	35.0	2.5	0.4m	14.49	13.1°	15.5g	•	•	3		B3M35025C
B3M50025	1/2"	50.0	2.5	0.5m	18.38	9.3°	34.5g	•	•	3		B3M50025C

S-Mount Lenses (M12x0.5)

S-Mount Lenses (M12x0.5)

1-2 Megapixel Board Lenses



Lensagon No.	Image format	Focal length	Aperture	M.O.D.	Back focal length	FOV (dia.)	Weight	IR corr.	IR cut Option	Megapixel	Lensagon No. with IR cut
BM2118V2	1/3"	2.1	2.2	0.2m	6.3	170°	6.5g	•	•	1	BM2118V2C
BM2420	1/3"	2.4	2.0	0.15m	4.56	132°	6.0g	•	•	1	BM2420C
BM2820	1/3"	2.8	2.0	0.2m	5.29	122°	6.0g	•	•	1	BM2820C
BM2920S118	1/1.8"	2.95	2.8	0.15m	7.85	178°	13.0g	•	•	1	BM2920S118C
BM3618	1/3"	3.6	1.8	0.2m	6.59	100.2°	6.0g	•	•	1	BM3618C
B2M3814	1/2.5"	3.85	1.4	0.2m	6.76	121.9°	9.0g	•	•	2	B2M3814C
BSM4016S12	1/2"	4.0	1.6	0.2m	7.2	146°	7.0g	•	•	2	
BM4218	1/3"	4.2	1.8	0.2m	7.21	89°	7.0g	•	•	1	BM4218C
BM6018	1/3"	6.0	1.8	0.2m	9.33	60°	6.0g	•	•	1	BM6018C
BSM6016S12	1/2"	6.0	1.6	0.2m	8.73	88°	4.5g	•	•	2	
BM6020S12	1/2"	6.0	2.0	0.2m	10.7	85°	6.0g	•	•	1.3	
BM8018	1/3"	8.0	1.8	0.2m	5.4	45°	6.0g	•	•	1	BM8018C
BSM8016S12	1/2"	8.0	1.6	0.2m	5.4	62°	6.0g	•	•	2	
BM8020S12	1/2"	8.0	2.0	0.2m	8.6	56°	6.0g	•	•	1.3	
BM9040	1/3"	9.0	4.0	0.1m	8.0	34.4°	3.9g	•	•	1.3	
BM9050	1/3"	9.0	5.0	0.1m	8.0	34.4°	3.9g	•	•	1.3	
BM10028S12	1/2"	10.0	2.8	0.4m	8.0	44°	6.0g	•	•	1.2	
B2M10030N2	1/2"	10.3	3.0	0.2m	8.77	54°	3.5g	•	•	2	B2M10030N2C
BM12018	1/3"	12.0	1.8	0.2m	6.54	28.4°	6.0g	•	•	1	BM12018C
BSM12016S12	1/2"	12.0	1.6	0.2m	6.54	38.6°	6.0g	•	•	2	
BSM16016S12	1/2"	16.0	1.6	0.2m	6.58	24°	7.0g	•	•	2	
BM16018	1/3"	16.0	1.8	0.2m	6.59	21°	6.0g	•	•	1	BM16018C

VGA & High Resolution Board Lenses



Lensagon No.	Image format	Focal length	Aperture	M.O.D.	Back focal length	FOV (dia.)	Weight	IR corr.	IR cut Option	Megapixel	Lensagon No. with IR cut
BK1220	1/4"	1.2	2.0	0.2m	3.4	192°	5.2g	•	•		BK1220C
BK1820	1/4"	1.8	2.0	0.2m	3.65	160°	5.5g	•	•		BK1820C
BT1922	1/4"	1.9	2.2	0.05m	4.7	156°	3.5g	•	•		BT1922C
BT2120	1/3"	2.1	2.0	0.2m	4.92	151°	6.5g	•	•		BT2120C
BHR2125	1/3"	2.1	2.5	0.2m	4.25	165.7°	6.1g	•	•		
BT2520	1/3"	2.5	2.0	0.2m	5.18	140°	5.3g	•	•		BT2520C
BHR2525	1/3"	2.5	2.5	0.2m	5.04	142.7°	6.8g	•	•		
BT2920	1/3"	2.9	2.0	0.2m	5.02	138°	4.5g	•	•		BT2920C
BT3020	1/3"	3.0	2.0	0.2m	5.35	124°	3.5g	•	•		BT3020C
BHR3020	1/3"	3.0	2.0	0.2m	5.67	126.0°	5.9g	•	•		
BT3620	1/3"	3.6	2.0	0.2m	5.00	100°	4.1g	•	•		BT3620C
BK4320	1/3"	4.3	2.0	0.2m	6.1	85°	6.0g	•	•		BK4320C
BHR4318	1/3"	4.3	1.8	0.2m	6.16	83.1°	4.0g	•	•		
BHR5620	1/3"	5.6	2.0	0.2m	8.07	65.3°	4.0g	•	•		
BT6020V2	1/3"	6.1	2.0	0.2m	8.03	62°	6.5g	•	•		BT6020V2C
BT8020N	1/3"	8.0	2.0	0.2m	8.25	44°	3.5g	•	•		BT8020NC
BHR8020	1/3"	8.0	2.0	0.2m	7.6	43.0°	6.0g	•	•		
BT12020	1/3"	12.0	2.0	0.4m	8.97	29°	3.2g	•	•		BT12020C
BHR12020	1/3"	12.0	2.0	0.2m	6.7	28.0°	4.5g	•	•		
BT16020	1/3"	16.0	2.0	0.4m	9.98	22°	3.9g	•	•		BT16020C
BHR16012S12	1/2"	16.0	1.2	0.3m	7.2	21.8°	11.0g	•	•		
B16020S12	1/2"	16.0	2.0	0.2m	12.3	27.8°	4.2g	•	•		
BT25020S12	1/2" (1/3")	25.0	2.0	0.2m	8.29	18.6° (13.8°)	7.0g	•	•		BT25020S12C
B25020S12	1/2"	25.0	2.0	0.2m	11.8	18.2°	17.6g	•	•		
B35020S12	1/2"	35.0	2.0	0.2m	18.9	13.0°	15.4g	•	•		
B50020S12	1/2"	50.0	2.0	0.4m	33.9	9.2°	27.1g	•	•		

S-Mount
C-Mount
Accessories
Telecentric
Line Scan
Macro
Illumination

S-Mount Lenses (M12x0.5)

Waterproof Automotive Board Lenses

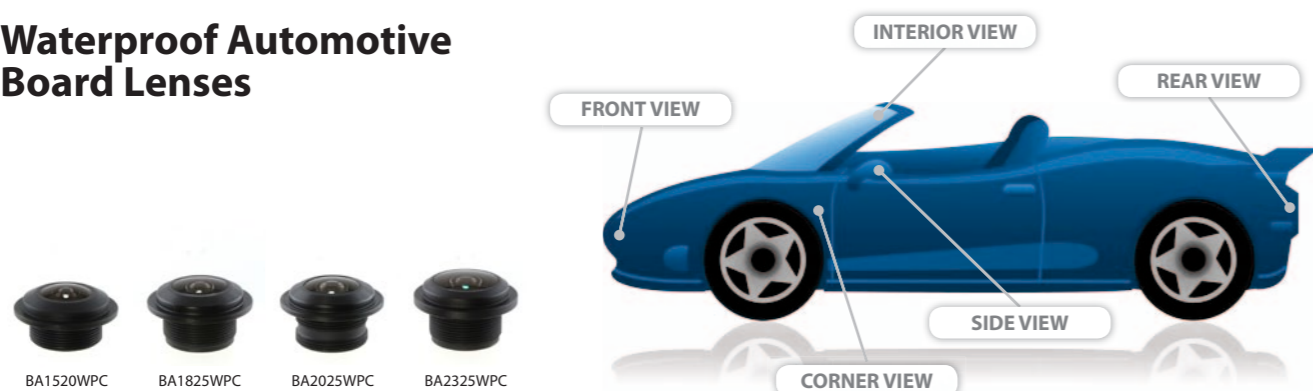

Lensagon No.	Image format	Focal length	Aperture	M.O.D.	Back focal length	FOV (dia.)	Weight	IR corr.	IR cut Option	Megapixel	Lensagon No. with IR cut
BA1520WPC	1/4"	1.5	2.0	0.2m	2.2	163.0°	5.5g		only	1	x
BA1825WPC	1/4"	1.8	2.5	0.2m	2.2	160.0°	5.5g		only		x
BA2025WPC	1/4"	2.0	2.5	0.2m	2.47	160.0°	5.5g		only		x
BA2325WPC	1/3"	2.3	2.5	0.2m	2.7	163.0°	6.0g		only		x

Fisheye Board Lenses



Lensagon No.	Image Format	Focal Length	Aperture	M.O.D.	Back Focal Length	Angle of View (D)	Image Circle	Weight	IR corr.	IR cut option	Mega-pixel	Lensagon No. with IR cut
NEW BF10M10526S132	1/3.2"	1.05	2.6	0.1m	3.2	200°	3.5	13.7g	•	•	10	BF10M10526S132C
BF5M11920	1/3.2"	1.19	2.0	0.2m	6.44	185°	3.24	14.7g	•	•	5	BF5M11920C
BFM1220C	1/3"	1.2	2.0	0.2m	2.91	190°	3.84	7.5g		only	1.3	
NEW BF16M220D	1/2.3"	1.2	2.5	0.1m	2.95	220°	4.2	14g		•	16	BF16M220DC
BF2M12520	1/3"	1.25	2.0	0.15m	6.44	185°	3.6	14g	•	•	2	BF2M12520C
NEW BF5M12721	1/4"	1.27	2.1	0.1m	4.18	185°	2.8	4.7g	•	•	5	BF5M12721C
BF5M13720	1/2.5"	1.37	2.0	0.15m	5.57	183°	4.15	20.5g	•	•	5	BF5M13720C
BF9M1422	1/2.3"	1.41	2.2	0.1m	3.69	183°	4.5	24.0g	•	•	9	BF9M1422C
NEW BF10M14520S123	1/2.3"	1.45	2.0	0.1m	4.54	190°	4.6	14.7g	•	•	10	BF10M14520S123C
NEW BFM1524S125	1/2.5"	1.49	2.4	0.06m	2.94	183°	4.7	4.0g		•	1.3	BFM1524S125C
NEW BF5M15828S125	1/2.5"	1.58	2.8	0.1m	5.75	180°	4.1	10.9g	•	•	5	BF5M15828S125C
NEW BF10M19828S118	1/1.8"	1.98	2.8	0.1m	6.32	180°	5.6	15.6g	•	•	10	BF10M19828S118C
BF2M2020	2/3"	2.0	2.0	0.08m	6.17	175°	6.0	18.5g	•		2	BF2M2020C
BF2M2020S23	2/3"	2.0	2.0	0.08m	6.17	195°	6.54	18.0g	•		2	BF2M2020S23C
NEW BF3M2122S13	1/3"	2.1	2.2	0.1m	3.67	184°	4.8	3.9g	•	•	3	BF3M2122S13C
NEW BF5M2223S129	1/2.9"	2.2	2.3	0.1m	4.71	195°	6.2	4.8g	•	•	5	BF5M2223S129C

S-Mount Lenses (M12x0.5)

Pinhole Board Lenses



Lensagon No.	Image format	Focal length	Aperture	M.O.D.	Back focal length	FOV (dia.)	Weight	IR corr.	IR cut Option	Megapixel	Lensagon No. with IR cut
NEW BP2824S13	1/3"	2.8	2.4	0.1m	3.1	125°	1.5g		•		BP2824S13C
BPM3718	1/3"	3.7	1.8	0.1m	3.55	104°	3.1g	•	•	1	BPM3718C
NEW BP3M3728S127	1/2.7"	3.7	2.8	0.3m	3.7	108.4°	1.8g		•	3	BP3M3728S127C

Light Sensitive Board Lenses



Lensagon No.	Image format	Focal length	Aperture	M.O.D.	Back focal length	FOV (dia.)	Weight	IR corr.	IR cut Option	Megapixel	Lensagon No. with IR cut
BL6012	1/3"	6.0	1.2	0.2m	6.96	44.3°	32.5g				x
BL8012	1/3"	8.0	1.2	0.2m	7.7	34.1°	35.0g				x
BL12014	1/3"	12.0	1.4	0.3m	13.7	22.4°	28.0g				x
BL16014	1/3"	16.0	1.4	0.3m	11.35	17.1°	28.0g				x

with Manual Iris

Lensagon No.	Image format	Focal length	Aperture	M.O.D.	Back focal length	FOV (dia.)	Weight	IR corr.	IR cut Option	Megapixel	Lensagon No. with IR cut
MB4012	1/3"	4.0	1.2	0.2m	6.5	62.2°	34.0g				x
MB6012	1/3"	6.0	1.2	0.2m	6.96	44.3°	33.0g				x
MB8012	1/3"	8.0	1.2	0.2m	7.7	34.1°	30.0g				x
MB12014	1/3"	12.0	1.4	0.3m	13.7	22.4°	31.5g				x
MB16014	1/3"	16.0	1.4	0.3m	11.35	17.1°	29.0g				x



Kennen Sie schon www.optowiki.info?

Dort finden Sie viele interessante Fragen zu Optik- und überraschende Antworten!

F: Können s-mount Objektive so gut sein wie c-mount Objektive?

A: Sogar noch besser!
Obwohl eine natürliche Obergrenze für die Auflösung von s-mount Objektiven besteht, gibt es einige in einer Qualität, die man bei c-mount nicht findet, oder nur zu drastisch höheren Preisen.

Q: Warum ist das Bild der Kamera total verschwommen!?

A: ... also nicht nur 'etwas' unscharf?
Dann könnte es sein, dass Sie ein cs-mount Objektiv auf einer c-Mount Kamera verwenden. Bei cs-mount Kameras sind es ca. 5mm weniger von der Vorderkante bis zum Sensor als bei c-mount Kameras.

Did you already know www.optowiki.info?

You will find many interesting questions about optics and surprising answers!

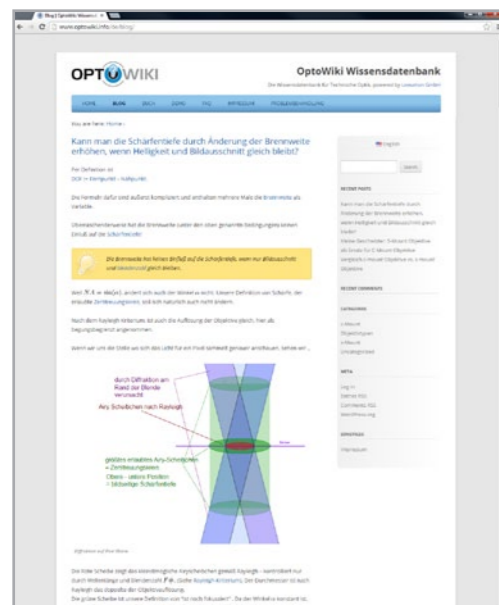

Q: Can s-mount lenses be as good as c-mount lenses?

A: Even better!
Although there is a natural limit on the quality of s-mount lenses, some of them provide a quality not found in the c-mount area, or only for dramatically higher prices.

Q: Why is the camera image totally blurred!?

A: ... not just 'something' out of focus!? It could be that you are using a CS-mount lens on a C-mount camera. At cs-mount cameras it is about 5mm less from the leading edge of the mechanics to the sensor

8 Megapixel C-Mount Lenses

Designed for the new 8 Megapixel CCDs



Features

- High performance from macro to infinity
- Suited fine for factory automation and also high end surveillance

Lensagon No.	Focal length	Aperture	Range of WD	TV distortion *	Angle of view (VxH)	Filter size	Format
C8M1614GSV2	16mm	1.4	0.2m~∞	<1%	44.0° x 32.0°	M49 P=0.75	1"
C8M2014GSV2	20mm	1.4	0.2m~∞	<1%	35.0° x 26.4°	M49 P=0.75	1"
C8M2514GSV2	25mm	1.4	0.2m~∞	<1%	28.9° x 21.6°	M49 P=0.75	1"
C8M2220S43	16mm	2.0	0.5m~∞	<1%	45.5° x 34.5°		4/3"
C8M3520S43	16mm	2.0	0.4m~∞	<1%	26.5° x 20.5°		4/3"

Discover the features of our new website!

[www.lensation.de]

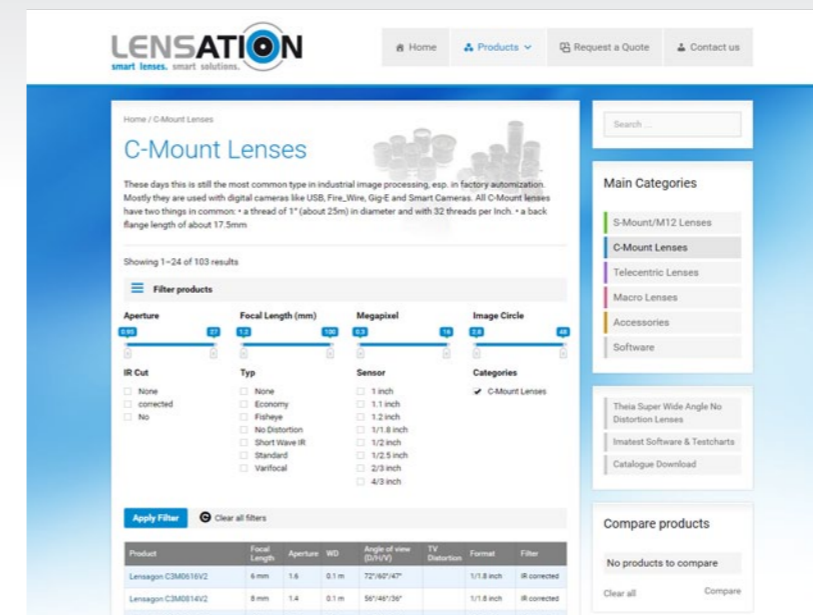

Filter the search result.

Set the properties and ranges of technical data according to your needs and you will only see matching lenses.

Compare multiple products.

A further feature to help you narrow down your selection is the product comparison. Mark the products you want to compare, and see which solution is best for you.

Get all product details at a glance.

If you want to take a closer look at a product, the product detail page offers you all relevant information. You'll find technical drawings and PDF datasheets for download.

C-Mount Lenses

5 Megapixel High Resolution Machine Vision Lenses

Suitable for inspection and alignment, required for high accuracy

Features

- Suitable for 5 mega upto 10 mega pixel CCDs
- Focal length longer than f16mm is compatible with 1.1 CCD
- High performance, compared to conventional CCTV lenses
- High resolution at whole range of WD and excellent brightness
- Robust design, suitable for machine vision applications
- Two different mount types available : slip mount for all lenses, fix mount for 25mm, 50mm, 75mm



Lensagon No.	Focal length	Aperture	Range of WD	TV distortion *	max. Magnification	Filter size	Format
C5M0528	5mm	2.8	0.05m ~ ∞	-0.55%	0.044x	M55 P=0.75	2/3"
C5M0818	8mm	1.8	0.1m ~ ∞	0.31%	0.078x	M40.5 P=0.75	2/3"
C5M1214	12mm	1.4	0.1m ~ ∞	-0.31%	0.1x	M37.5 P=0.5	2/3"
C5M1618GS	16mm	1.8	0.033m ~ ∞	-0.27%	0.3x	M49 P=0.75	1.1"
C5M2514GS	25mm	1.4	0.08m ~ ∞	-0.09%	0.3x	M52 P=0.75	1.1"
C5M3514GS	35mm	1.4	0.11m ~ ∞	-0.05%	0.3x	M46 P=0.75	1.1"
C5M5018GS	50mm	1.8	0.192m ~ ∞	-0.01%	0.3x	M49 P=0.75	1.2"
C5M7518GS	75mm	1.8	0.29m ~ ∞	0.00%	0.3x	M55 P=0.75	1.2"

* TV distortion indicates a value for the closest working distance with 2/3" CCD

C-Mount Lenses

Megapixel C-Mount Lenses (C3M Series)

Features:

- Compatible with over 3,000,000 pixel CCDs
- Low optical distortion
- High performance and excellent value for money
- Focal length 4mm coming soon!
- Lock screws for manual iris and manual focus.



Lensagon No.	Focal length	Aperture	Range of WD	Angle of View (HxV)					Weight	Format
				1/3"	1/2"	1/1.8"	2/3"	1"		
C3M0616V2	6mm	1.6	0.15m ~ ∞	53.8° x 33.2°	67.2° x 43.3°	45.1° x 71.1°	-	-	91.1g	1/1.8"
C3M0814V2	8mm	1.4	0.20m ~ ∞	33.2° x 25.2°	43.4° x 33.2°	48.3° x 36.4°	-	-	64.8g	1/1.8"
C3M1216V2	12mm	1.6	0.15m ~ ∞	22.4° x 17.4°	29.5° x 22.4°	33.2° x 24.6°	40.2° x 30.5°	-	68.2g	2/3"
C3M1616V2	16mm	1.6	0.30m ~ ∞	17.4° x 12x5°	22.4° x 17.4°	25.2° x 18.5°	29.5° x 22.6°	-	89g	2/3"
C3M2518V2	25mm	1.8	0.30m ~ ∞	10.6° x 8.1°	14.4° x 10.6°	16.2° x 12.9°	19.6° x 15.2°	-	55g	2/3"
C3M3520V2	35mm	2.0	0.40m ~ ∞	7.5° x 5.5°	10.3° x 7.5°	11.4° x 8.4°	14.2° x 10.5°	-	56g	2/3"
C3M5025V2	50mm	2.5	0.50m ~ ∞	5.3° x 4.7°	7.2° x 5.3°	8.1° x 6.5°	10.3° x 7.3°	-	79g	2/3"
C3M7528V2	75mm	2.8	1.20m ~ ∞	3.4° x 2.5°	4.5° x 3.4°	5.3° x 4.4°	6.43° x 5.2°	9.2° x 6.9°	167.5g	1"

Megapixel Low Distortion CCTV Lenses (ND series)

Features

- High resolution, compatible with CCDs of over 1,000,000 pixel
- High performance at less than WD500mm
- Low color aberration and low TV distortion
- Micro-photography without extension ring



1/2" format (ND series)

Lensagon No.	Focal length	Aperture	Range of WD	TV distortion	Angle of View (VxH)	Filter screw	Format
CMFA0420ND	4mm	2.0	0.1m~∞	0.91%	59.96° x 75.14°	M27 P=0.5	1/2"
CMFA0622ND	6mm	2.2	0.1m~∞	-0.01%	40.47° x 52.35°	M30.5 P=0.5	1/2"
CMFA1022ND	10mm	2.2	0.1m~∞	-0.08%	26.31° x 34.61°	M27 P=0.5	1/2"

2/3" format (ND series)

Lensagon No.	Focal length	Aperture	Range of WD	TV distortion	Angle of View (VxH)	Filter screw	Format
CMFA1520ND	15mm	2.0	0.1m~∞	-0.09%	24.11° x 31.79°	M27 P=0.5	2/3"
CMFA2020ND	20mm	2.0	0.1m~1m	-0.10%	18.20° x 24.11°	M27 P=0.5	2/3"
CMFA2520ND	25mm	2.0	0.15m~1m	-0.01%	14.75° x 19.58°	M27 P=0.5	2/3"
CMFA3020ND	30mm	2.0	0.2m~1m	-0.02%	12.55° x 16.69°	M27 P=0.5	2/3"
CMFA3519ND	35mm	1.9	0.3m~1m	-0.03%	10.77° x 14.32°	M27 P=0.5	2/3"
CMFA5025ND	50mm	2.5	0.4m~1m	-0.03%	7.82° x 10.38°	M27 P=0.5	2/3"
CMFA7538ND	75mm	3.8	0.4m~1m	-0.01%	5.11° x 6.81°	M27 P=0.5	2/3"

C-Mount Lenses

C-Mount Lenses

Megapixel High Resolution CCTV Lenses (MJ series)

Lensagon No.	Focal length	Aperture	Range of WD	TV distortion	Angle of View (VxH)	Filter screw	Format
CM0614MJ	6mm	1.4	0.2m~∞	-0.96%	44.3° x 57.4°	M30.5 P=0.5	1/2"
CM1614MJ	16mm	1.4	0.25m~∞	-0.28%	23.3° x 30.7°	M25.5 P=0.5	2/3"
CM2514MJ	25mm	1.4	0.25m~∞	-0.3%	15.1° x 20.1°	M25.5 P=0.5	2/3"
CM3520MJ	35mm	2.0	0.25m~∞	-0.2%	10.4° x 14.3°	M25.5 P=0.5	2/3"
CM5028MJ	50mm	2.8	0.5m~∞	-0.2%	7.4° x 9.9°	M25.5 P=0.5	2/3"

High Quality C-Mount Lenses

Features

- Cover a wide range of uses from inspection to factory automation
- Vibration-resistant focus and iris locks available
- Compatible with 1/3", 1/2", 2/3", 1" 400,000 pixel cameras



1/2" format

Lensagon No.	Focal length	Aperture	Operation Range	Angle of View (V x H)	Filter screw	Format
CY0316	3.5mm	1.6	0.1m~∞	69.0° x 85.0°	M43 P=0.75	1/2"
CY0614	6mm	1.4	0.2m~∞	42.0° x 54.5°	M27 P=0.5	1/2"
CY1214	12mm	1.4	0.3m~∞	22.0° x 29.0°	M27 P=0.5	1/2"

2/3" format

Lensagon No.	Focal length	Aperture	Operation Range	Angle of View (V x H)	Filter screw	Format
CY0614S23	6mm	1.4	0.2m~∞	81.9° x 61.2°	no filter thread	2/3"
CY0813	8mm	1.3	0.2m~∞	45.0° x 57.8°	M25.5 P=0.5	2/3"
CY1614	16mm	1.4	0.4m~∞	23.2° x 30.7°	M27 P=0.5	2/3"
CY2514	25mm	1.4	0.5m~∞	21.6° x 28.5°	M27 P=0.5	2/3"
CY3519	35mm	1.9	0.5m~∞	10.8° x 14.4°	M27 P=0.5	2/3"
CY5018	50mm	1.8	1m~∞	7.9° x 10.5°	M30.5 P=0.5	2/3"
CY7527	75mm	2.7	1m~∞	4.9° x 6.6°	M30.5 P=0.5	2/3"
CY10035	100mm	3.5	1m~∞	3.8° x 5.1°	M30.5 P=0.5	2/3"

Megapixel High Resolution 1" C-Mount Lenses

Lensagon No.	Focal length	Aperture	Operation Range	Angle of View (H x V)	Filter screw	Format
CM0618GS	6mm	1.8	0.1m~∞	96.8° x 79.4°		1"
CM0814GS	8mm	1.4	0.1m~∞	79.7° x 63.0°	M55 P=0.75	1"
CM1214GS	12mm	1.4	0.3m~∞	55.6° x 42.5°	M27 P=0.5	1"
CM1614GS	16mm	1.4	0.3m~∞	44.3° x 33.6°	M35.5 P=0.5	1"
CM2514GS	25mm	1.4	0.3m~∞	29.3° x 22.0°	M35.5 P=0.5	1"
CM3514GS	35mm	1.4	0.3m~∞	20.9° x 15.8°	M35.5 P=0.5	1"
CM5014GS	50mm	1.4	0.5m~∞	14.5° x 10.8°	M40.5 P=0.5	1"
CM7518GS	75mm	1.8	1.0m~∞	9.7° x 7.3°	M46.5 P=0.75	1"

High Speed F0.95 C-Mount Lenses

Lensagon No.	Focal length	Aperture	Operation Range	Angle of View (V x H)	Filter screw	Format
CHS17095	17mm	0.95	0.5m~∞	22.0° x 29.0°	M40.5 P=0.5	2/3"
CHS25095	25mm	0.95	0.5m~∞	21.7° x 28.7°	M40.5 P=0.5	1"
CHS50095	50mm	0.95	0.7m~∞	11.0° x 14.6°	M62.0 P=0.75	1"

Megapixel Low Distortion C-Mount Varifocal Lenses

The CVM series maintains straight lines in wide angle images!

Utilising advanced lens technology to XD (extra low Dispersion) glass and an aspherical lens, this new multi-megapixel lens will pave the way for more possibilities in applications such as high end surveillance.

Features

- High resolution, compatible with CCDs of over 1,000,000 pixel
- Compact design and low distortion: Where "normal" 4.5mm lenses for 1/2" have a distortion of between 20% and 30%, this brand new aspherical lenses have a distortion of below 0.5% (T) on a 1/2" sensor.



Lensagon No.	Focal length	Aperture (max.)	Operation Range	TV Distortion	Angle of View (H x V)		Format
					Wide	Tele	
CVM0411ND	4.4 - 11mm	1.6	0.3m ~ ∞	W: -0.2% T: 0.35%	76.6° x 61.2°	36.7° x 28.0°	1/1.8"
CVM1664NDGS	16 - 64mm	1.8	1.0m ~ ∞	W: -3.4% T: 0.2%	45.9° x 34.2°	11.7° x 8.8°	1"

Fisheye C/CS-Mount Lenses

We offer of high quality Fisheye-Lenses, supporting up to 5 Megapixel sensors.

A Fisheye lens is essentially a wide angle lens which will take a really wide picture (although a somewhat distorted wide picture). They are normally used to take pictures of wide areas.



Lensagon No.	Image Format	Focal Length	Aperture (max.)	M.O.D.	Angle of View	Note	IR corr.	Image Circle	Mega-pixel
CSF5M1414	1/2"	1.4mm	1.4	0.08m ~ ∞	182°	CS-Mount	•	4.8mm	5
CF5M1414	1/2"	1.4mm	1.4	0.08m ~ ∞	182°	C-Mount	•	4.8mm	5

C-Mount Lenses

Economy Megapixel C-Mount Lenses

Lensagon No.	CM6014N3	CM8014N3	CM12014N3	CVM40100	CVM60120
					
Image Format	1/2"	1/2"	1/2"	1/2"	1/2"
Mount	C	C	C	C	C
Focal Length	6mm	8mm	12mm	4.0~10mm	6.0~12mm
Aperture	1:1.4	1:1.4	1:1.4	1:1.6	1:1.6
M.O.D.	0.3m	0.3m	0.3m	0.2m	0.2m
Zoom	-	-	-	Manual with lock	Manual with lock
Focus	Manual with lock	Manual with lock	Manual with lock	Manual with lock	Manual with lock
Iris	Manual with lock	Manual with lock	Manual with lock	Manual	Manual
Angle of View (HxV)	66.2° x 49.6°	48.2° x 36.1°	30.8° x 24.2°	Wide: 87.2° x 65.4° Tele: 44.4° x 33.3°	Wide: 53.0° x 39.75° Tele: 28.0° x 21.0°
Back Focal Length	11.6mm	13.8mm	15.2mm	9.5mm	9.67mm
Weight	89g	95g	95g	72g	72g
Note	Megapixel	Megapixel	Megapixel	Megapixel	Megapixel

Accessories

Accessories

LENSATION offers a wide range of accessories for Board Lenses and C-/CS-Mount lenses. You will find simple extension/lock rings, S-Mount holders and e.g. our self-developed, focussable S- to C-Mount adapter AD05OH.



Example combination of Lock Ring (red) and C-Mount to S-Mount Adapter on a C-Mount smart camera.



S-Mount Accessories

- 

CH303015-20M
CS-Mount Lens Holder for PCB
To be mounted directly to PCB boards. Configurable with filter.
- 

ST05
M12 Extension ring 5mm
Material: Aluminium, Height: 5 mm
- 

ST10
M12 Extension ring 10mm
Material: Aluminium, Height: 10 mm
- 

M12TM14
M12 to M14 Adapter
Material: Aluminium. For using M12x0.5 lenses in M14x0.5 mounts
- 

SH01F08V3
S-mount lens holder 8mm
Material: Plastic, mounting hole distance 22mm, Height: 8 mm, Width: 20.3 mm
- 

SH02M13V3
S-mount lens holder 13mm
Material: Plastic, mounting hole distance 22mm, Height: 13 mm, Width: 20.3 mm
- 

SH03H16V2
S-mount lens holder 16mm
Material: Plastic, mounting hole distance 22mm, side hole for lock screw. Inner height 5.5mm
- 

LRM12V2
M12 x 0.5 Lock Ring
Material: Aluminium, Black anodized, Height: 2 mm, Diameter: 15.8 mm
- 

FAM12D14H08
Iris/Filter adapter for M12x0.5
allows to add a filter to standard S-Mount (M12x0.5) Lenses or to modify the F-Number.

C-Mount Accessories

- 

ADCTS
C-Mount to CS-Mount Adapter
with male and female thread, 5mm effective height, for use of c-mount lenses with cs-mount cameras
- 

CT40
Extension Tube 40mm
Material: Aluminium, Height: 40 mm
40mm extension tube for C-Mount lenses.
- 

AD02F
S-Mount to C-Mount Adapter Flat
Male c-mount thread and female M12x0.5 thread, for use of s-mount lenses in c-mount cameras.
- 

AD03H
S-Mount to C-Mount Adapter High
Male c-mount thread and female M12x0.5 thread, for use of s-mount lenses in c-mount cameras.
- 

AD01S
S-Mount to C-Mount Adapter Standard
Male c-mount thread and female M12x0.5 thread, for use of s-mount lenses in c-mount cameras.
- 

AD04M
S-Mount to C-Mount Adapter Medium
Male c-mount thread and female M12x0.5 thread, H: 6mm, for s-mount lenses in c-mount cameras.
- 

AD05OH
Focussable s-mount to c-mount adapter
Adapter with a male c-mount thread and a 12mm hole for M12x0.5 (s-mount) lenses.
- 

LRICM
C-Mount Lock Ring Inside Thread
Material: Aluminium, Black anodized, Height: 2 mm, Outside diameter: 31mm
- 

LROCM
C-Mount Lock Ring Outside Thread
Material: Aluminium, Black anodized, Height: 2.5 mm, Inside diameter: 20mm

S-Mount
C-Mount
Telecentric
Line Scan
Macro
Illumination

Accessories

Telecentric Lenses

Telecentric Lenses

Double Side Telecentric Lenses

- These lenses are double side telecentric lens which are best choice for the accurate dimensional measurement of large part sample.
- No perspective error over the whole F.O.V.
- IRIS diaphragm for adjusting D.O.F.
- Apply High Mega Pixel CCD like 5M, 4M,16M, 29M. (Diagonal length from 11mm to 43mm)
- Good for engine parts, metal parts, molding and casting semiconductor parts application.
- M58 Mount, C-mount, F-mount



T29M Series

Lensagon No.	Mag.	WD	Res. (Obj.)	NA	F No.	D.O.F. (μm)	Telecentricity (<degree)	Optical Distort. (%)	CCD size (max.)	Mount
T29M-024-400I	0.24X	400	28	0.012	10	7640	0.05	0.03	43mm	M58
T29M-038-265I	0.38X	265	17.6	0.019	10	3050	0.04	0.03	43mm	M58
T29M-0563-160I	0.563X	160	12	0.028	10	1270	0.05	0.04	43mm	M58
T29M-0664-181I	0.664X	181	8.4	0.04	8.3	1110	0.05	0.05	43mm	M58

T4M Series

Lensagon No.	Mag.	WD	Res. (Obj.)	NA	F No.	D.O.F. (mm)	Telecentricity (<degree)	Optical Distort. (%)	CCD size (max.)	Mount
T4M-01-470I	0.1X	470	51.6	0.0065	7.7	61.6	0.05	0.026	1.2"	F

TDC Series

Lensagon No.	Mag.	WD	Res. (Obj.)	NA	F No.	D.O.F. (mm)	Telecentricity (<degree)	Optical Distort. (%)	CCD size (max.)	Mount
NEW TDC-0044-398	0.044 X	398	116	0.0029	7.5	310	0.05	0.03	1/2"	C
NEW TDC-0061-398	0.061 X	398	78	0.0043	7	150	0.05	0.03	2/3" (11mm)	C
TDC-012-230	0.12X	230	40.91	0.0082	7.3	40.5	0.04	0.03	2/3" (11mm)	C
TDC-0138-183	0.138X	183	38.563	0.0095	7.5	30.7	0.05	0.03	2/3" (11mm)	C
TDC-0157-160	0.157X	160	32.259	0.0104	7.5	24.3	0.05	0.03	2/3" (11mm)	C
TDC-0184-135	0.184X	135	27.5	0.0122	7.5	17.7	0.04	0.05	2/3" (11mm)	C
TDC-024-108	0.24X	108	20.96	0.016	7.5	10.4	0.04	0.04	2/3" (11mm)	C
NEW TDC-0255-70	0.255X	70	20.97	0.016	8	9.8	0.04	0.04	2/3" (11mm)	C
TDC-035-72	0.35X	72	14.399	0.0233	7.5	4.9	0.05	0.04	2/3" (11mm)	C

I = Manual Iris, C = Coaxial, IC = Both

Object Side Telecentric Lenses

T25M Series

- This telecentric lens supports up to 25 megapixel CCD cameras with 32mm diagonal length.
- It is compatible with 12M CCD camera according to the customer requirement
- High resolution lens & No perspective error over the whole F.O.V.
- Iris diaphragm adapted for adjusting D.O.F.
- Possible to change M48-Mount / F-Mount.



Lensagon No.	Mag.	WD	Res. (Obj.)	NA	F No.	D.O.F. (μm)	Telecentricity (<degree)	Optical Distort. (%)	CCD size (max.)	Mount
T25M-033-347I	0.33X	347	16.8	0.0124	8	2940	0.03	0.02	25M (32mm)	M48
T25M-035-213I	0.35X	213	14.39	0.0233	7.5	2200	0.03	0.08	25M (32mm)	M48
T25M-045-270I	0.45X	270	9.31	0.036	6.25	1110	0.03	0.08	25M (32mm)	F
T25M-046-150I	0.46X	150	10.2	0.033	7	1200	0.03	0.04	25M (32mm)	M48
T25M-05-237I	0.5X	237	8.4	0.04	6.25	900	0.03	0.08	25M (32mm)	M48
T25M-06-132I	0.6X	132	7	0.048	6.3	630	0.03	0.04	25M (32mm)	M48
NEW T25M-08-240I	0.8X	240	6.3	0.0533	7.5	421	0.03	0.04	25M (32mm)	F
NEW T25M-082-270I	0.82X	270	6.1	0.0546	7.5	401	0.03	0.04	25M (32mm)	F
T25M-092-170I	0.92X	170	5.2	0.064	7.14	303	0.04	0.03	25M (32mm)	M48
NEW T25M-12-155I	1.2X	155	4.2	0.08	7.5	187	0.03	0.03	25M (32mm)	F
NEW T25M-135-110I	1.35X	110	4.5	0.075	9	178	0.03	0.01	25M (32mm)	F
T25M-15-100I	1.5X	100	4.47	0.075	10	160	0.03	0.03	25M (32mm)	F
NEW T25M-30-78/C	3.0X	78	3.4	0.1	15	60	0.04	0.09	25M (32mm)	F

I = Manual Iris, C = Coaxial, IC = Both / D.O.F Calculation: Permissible of circle of confusion : 18μm

T12M Series

- High resolution lens, no perspective error
- Compatible with 12M sensor
- Iris diaphragm adapted for adjusting D.O.F.



Lensagon No.	Mag.	WD	Res. (Obj.)	NA	F No.	D.O.F. (μm)	Telecentricity (<degree)	Optical Distort. (%)	CCD size (max.)	Mount
NEW T12M-055-271	0.55X	271	9.1	0.037	7.4	1000	0.03	0.01	12M (28mm)	M48
NEW T12M-0785-275	0.785X	275	6.3	0.053	7.4	528	0.03	0.01	12M (28mm)	M48

I = Manual Iris, C = Coaxial, IC = Both / D.O.F Calculation: Permissible of circle of confusion : 22μm

S-Mount
C-Mount
Accessories
Telecentric
Line Scan
Macro
Illumination

Telecentric Lenses

TF8M Series

- High telecentricity: no perspective error.
- Telecentric lenses for large detectors 4M (15.2mm x 15.2mm) and 1.2"
- Iris diaphragm for adjusting D.O.F.
- Wide magnification range from 0.315X to 2.0X
- Good for semiconductor & SMT & PCB components measurement



Lensagon No.	Mag.	WD	Res. (Obj.)	NA	F No.	D.O.F. (μm)	Telecentricity (<degree)	Optical Distort. (%)	CCD size (max.)	Mount
TF8MHR-0315-130I	0.315X	130	13.3	0.0252	6.25	2780	0.03	0.03	8M (23mm)	F
TF8MHR-0318-265I	0.318X	265	10.6	0.0318	5	2180	0.03	0.08	8M (23mm)	F
TF8MHR-0348-130I	0.348X	130	12.1	0.0278	6.25	2300	0.03	0.04	8M (23mm)	F
TF8MHR-0348-200I	0.348X	200	12	0.0289	6	2180	0.03	0.02	8M (23mm)	F
TF8MHR-0385-130I	0.385X	130	12.4	0.027	7.1	2100	0.015	0.03	8M (23mm)	F
TF8MHR-042-132I	0.42X	132	5.4	0.0627	3.35	835.6	0.03	0.03	8M (23mm)	F
TF8M-042-130I	0.42X	130	16	0.021	10	2500	0.023	0.1	8M (23mm)	F
TF8MHR-049-132I	0.49X	132	7.5	0.0446	5.5	1010	0.03	0.05	8M (23mm)	F
TF8MHR-05-130I	0.5X	130	9.4	0.0357	7	1230	0.03	0.05	8M (23mm)	F
NEW TF8M-056-130I	0.56X	130	12.7	0.028	10	1400	0.03	0.06	8M (23mm)	F
TF8MHR-058-254I	0.58X	254	5.8	0.058	5	653.9	0.03	0.08	8M (23mm)	F
TF8MHR-06-130I	0.6X	130	6.2	0.054	5.6	684.4	0.03	0.06	8M (23mm)	F
TF8M-06-130I	0.6X	130	11.6	0.029	10.4	1300	0.23	0.1	8M (23mm)	F
TF8MHR-06-258I	0.6X	258	5.6	0.06	5	611.1	0.03	0.03	8M (23mm)	F
TF8MHR-064-130I	0.64X	130	5.8	0.0576	5.56	597.3	0.02	0.06	8M (23mm)	F
TF8MHR-06-310I	0.6X	310	7	0.048	6.25	671.4	0.03	0.08	8M (23mm)	F
TF8MHR-07-130I	0.7X	130	5.1	0.066	5.3	476	0.03	0.05	8M (23mm)	F
TF8MHR-10-157I	1.0X	157	4.7	0.071	7	308	0.03	0.06	8M (23mm)	F
TF8MHR-20-50/C	2.0X	50	3	0.112	8.93	98.2	0.03	0.04	8M (23mm)	F

I = Manual Iris, C = Coaxial, IC = Both / D.O.F Calculation: Permissible of circle of confusion : 22μm Possible to change mount

Telecentric Lenses

TC4M Series

- High telecentricity: no perspective error.
- Telecentric lenses for large detectors 4M (15.2mm x 15.2mm) and 1.2"
- Iris diaphragm for adjusting D.O.F.
- Wide magnification range from 0.315X to 2.0X
- Good for semiconductor & SMT & PCB components measurement
- C Mount & F Mount



Lensagon No.	Mag.	WD	Res. (Obj.)	NA	F No.	D.O.F. (μm/mm)	Telecentricity (<degree)	Optical Distort. (%)	CCD size (max.)	Mount
TC4MHR-015-255I	0.15X	255	31.4	0.0107	7	13.68mm	0.023	0.01	1" (16mm)	C
TC4MHR-016-240I	0.16X	240	30.5	0.011	7	12.03mm	0.03	0.01	1" (16mm)	C
NEW TC4MHR-0215-163I	0.215X	163	17.65	0.019	5.6	5300	0.03	0.03	1" (16mm)	C
TC4MHR-0234-130I	0.234X	130	15.97	0.021	5.6	4500	0.03	0.031	1" (16mm)	C
TC4MHR-026-130I	0.26X	130	14.3	0.0234	5.6	3644	0.03	0.031	1" (16mm)	C
TC4MHR-026-200I	0.26X	200	14.3	0.0234	5.6	3644	0.03	0.031	1" (16mm)	C
TC4MHR-0275-240I	0.275X	240	16.8	0.02	6.87	4000	0.025	0.04	1" (16mm)	C
TC4MHR-0312-130I	0.312X	130	7.21	0.0465	3.35	1514	0.03	0.031	1" (16mm)	C
TC4MHR-037-240I	0.37X	240	12.1	0.0277	6.66	2100	0.03	0.01	1" (16mm)	C
TC4MHR-0445-130I	0.445X	130	10.583	0.037	7	1560	0.023	0.065	1" (16mm)	C
NEW TC4MHR-07-65/C	0.7X	65	6,57	0,051	6,8	610	0,03	0,03	1"(16mm)	C
NEW TC4MHR-08-130C	0.8X	130	8,38	0,04	10	687	0,03	0,03	1"(16mm)	C
NEW TC4MHR-10-65/C	1.0X	65	5,41	0,062	8	352	0,03	0,03	1"(16mm)	C
NEW TC4M-10-110/C	1.0X	110	5,41	0,062	8	352	0,03	0,03	1"(16mm)	C
TC4MHR-22-40/C	2.2X	40	2.72	0.123	8.9	80.9	0.03	0.02	1" (16mm)	C
TC4MHR-30-40/C	3.0X	40	2.4	0.14	10.7	52.3	0.03	0.03	1" (16mm)	C

I = Manual Iris, C = Coaxial, IC = Both / D.O.F Calculation: Permissible of circle of confusion : 22μm

Telecentric Lenses

Telecentric Lenses

TC5M Series Ultra High Resolution

In combination with Mega pixel cameras (up to 2/3" CCD), you can get high-quality images.

- Designed for 5M CCD camera. (3.45m/pixel)
- Ultra High resolution and contrast with high NA.
- Very low distortion in whole field.
- Compact design with coaxial illumination.
- High telecentricity , No perspective error

TC5M Series (WD: 110mm)

Lensagon No.	Mag.	WD	Res. (Obj.)	NA	F No.	D.O.F. (μm)	Telecentricity (<degree)	Optical Distort. (%)	CCD size (max.)	Mount
TC5M-03-110 / C	0.3X	110	15.3	0.0219	6.9	3040	0.04	0.02	2/3"	C
TC5M-05-110 / C	0.5X	110	7.2	0.0465	5.38	861	0.02	0.02	2/3"	C
TC5M-05-110I / IC	0.5X	110	7.2	0.0465	5.38	861	0.02	0.02	2/3"	C
TC5M-07-110 / C	0.7X	110	5.15	0.0651	5.38	439	0.02	0.02	2/3"	C
TC5M-07-110I / IC	0.7X	110	5.15	0.0651	5.38	439	0.02	0.012	2/3"	C
TC5M-09-110 / C	0.9X	110	4.473	0.075	6	296	0.025	0.01	2/3"	C
TC5M-10-110 / C	1.0X	110	4.36	0.077	6.5	260	0.03	0.03	2/3"	C
TC5M-10-110I / IC	1.0X	110	4.36	0.077	6.5	260	0.03	0.03	2/3"	C
TC5M-20-110 / C	2.0X	110	3.7	0.09	11	110	0.05	0.03	2/3"	C

I = Manual Iris, C = Coaxial, IC = Both / D.O.F Calculation: Permissible of circle of confusion : 20μm



TC5M Series (WD: 65mm)

Lensagon No.	Mag.	WD	Res. (Obj.)	NA	F No.	D.O.F. (μm)	Telecentricity (<degree)	Optical Distort. (%)	CCD size (max.)	Mount
TC5M-05-65 / C	0.5X	65	8.4	0.04	6.25	1000	0.02	0.17	2/3"	C
TC5M-08-65 / C	0.8X	65	5.25	0.064	6.25	390.6	0.02	0.13	2/3"	C
TC5M-10-65 / C	1.0X	65	4.8	0.07	7.14	285.6	0.022	0.16	2/3"	C
TC5M-20-65 / C	2.0X	65	2.8	0.12	8.3	83	0.03	0.02	2/3"	C
TC5M-20-65I / IC	2.0X	65	2.8	0.12	8.3	83	0.03	0.02	2/3"	C
TC5M-30-65 / C	3.0X	65	2.15	0.156	9.6	42.7	0.02	0.05	2/3"	C
TC5M-30-65I / IC	3.0X	65	2.15	0.156	9.6	42.7	0.02	0.05	2/3"	C
TC5M-40-65 / C	4.0X	65	2.09	0.16	12.5	31.3	0.02	0.03	2/3"	C
TC5M-40-65I / IC	4.0X	65	2.09	0.16	12.5	31.3	0.02	0.03	2/3"	C

I = Manual Iris, C = Coaxial, IC = Both / D.O.F Calculation: Permissible of circle of confusion : 20μm

TC5M Series (WD: 130-170mm)

Lensagon No.	Mag.	WD	Res. (Obj.)	NA	F No.	D.O.F. (μm)	Telecentricity (<degree)	Optical Distort. (%)	CCD size (max.)	Mount
TC5M-0315-130I	0.315X	130	13.3	0.0252	6.25	2052	0.03	0.03	2/3"	C
TC5M-0348-130I	0.348X	130	12.1	0.0278	6.25	2060	0.03	0.04	2/3"	C
TC5M-042-130I	0.42X	130	5.4	0.0627	3.35	759	0.03	0.03	2/3"	C
TC5M-07-130I	0.7X	130	5.33	0.063	5.5	449	0.03	0.05	2/3"	C

TC5M Series (WD: 150mm)

Lensagon No.	Mag.	WD	Res. (Obj.)	NA	F No.	D.O.F. (μm)	Telecentricity (<degree)	Optical Distort. (%)	CCD size (max.)	Mount
TC5M-026-150I	0.26X	150	13.7	0.0245	5.3	3100	0.03	0.08	2/3"	C

TC5M Series (WD: 170mm)

Lensagon No.	Mag.	WD	Res. (Obj.)	NA	F No.	D.O.F. (μm)	Telecentricity (<degree)	Optical Distort. (%)	CCD size (max.)	Mount
TC5M-017-170I	0.17X	170	9.73	0.058	5	4775	0.03	0.06	2/3"	C
TC5M-03-170I	0.3X	170	17.94	0.0187	8	3550	0.03	0.01	2/3"	C
TC5M-065-170 / C	0.65X	170	5.78	0.058	5.6	530	0.02	0.06	2/3"	C

I = Manual Iris, C = Coaxial, IC = Both / D.O.F Calculation: Permissible of circle of confusion : 20μm

Telecentric Lenses

Telecentric Lenses

TCHR Series

- Designed for mega-pixel CCD camera. (4.65µm/pixel)
- High Resolution and contrast design in F.O.V.
- W.D Lineup of 65, 110, 130mm
- Support up to 2/3" cell camera.
- Various magnification with low-distortion design.
- Uniform coaxial illumination over the whole F.O.V.



TCHR Series (WD: 65mm)

Lensagon No.	Mag.	WD	Res. (Obj.)	NA	F No.	D.O.F. (µm/mm)	Telecentricity (<degree)	Optical Distort. (%)	CCD size (max.)	Mount
TCHR-013-60 I	0.13X	60	34.6	0.0097	6.7	31.7mm	0.03	0.08	1/2"	C
TCHR-05-65 / C	0.5X	65	11.2	0.03	8.3	2600	0.02	0.17	2/3"	C
TCHR-08-65 / C	0.8X	65	6.7	0.05	8	1000	0.02	0.134	2/3"	C
TCHR-10-65 / C	1.0X	65	6.7	0.05	10	800	0.022	0.16	2/3"	C
TCHR-15-65 / C	1.5X	65	4.8	0.07	10.7	380	0.022	0.07	1/2"	C
TCHR-20-65 / C	2.0X	65	4.5	0.074	13.4	268	0.05	0.03	2/3"	C
TCHR-24-65 / C	2.4X	63.6	4.8	0.07	17.2	239	0.015	0.1	2/3"	C
TCHR-30-65 / C	3.0X	65	4.04	0.083	18	120	0.02	0.14	1/2"	C
TCHR-40-65 / C	4.0X	65	3	0.11	18.18	90	0.05	0.03	2/3"	C
TCHR-60-65 / C	6.0X	65	3	0.11	27.2	61	0.05	0.03	2/3"	C
TCHR-100-65 / C	10.0X	65	2.2	0.15	33.3	27	0.01	0.14	1/2"	C
TCHR-120-65 / C	12.0X	65	2.1	0.161	37.3	21	0.004	0.1	1/2"	C

I = Manual Iris, C = Coaxial, IC = Both / D.O.F Calculation: Permissible of circle of confusion : 40µm

TCHR Series (WD: 110mm)

Lensagon No.	Mag.	WD	Res. (Obj.)	NA	F No.	D.O.F. (µm)	Telecentricity (<degree)	Optical Distort. (%)	CCD size (max.)	Mount
TCHR-035-110-S12/C	0.35X	110	21.1	0.016	11	4500	0.03	0.05	1/2"	C
TCHR-05-110-S13 / C	0.5X	110	11.2	0.03	8.3	2600	0.03	0.02	1/3"	C
TCHR-05-110 / C	0.5X	110	14.9	0.0225	11.1	3500	0.02	0.15	2/3"	C
TCHR-08-110 / C	0.8X	110	11.2	0.03	13.2	1650	0.017	0.15	2/3"	C
TCHR-10-110 / C	1.0X	110	6.7	0.05	10	800	0.03	0.15	2/3"	C
TCHR-15-110 / C	1.5X	110	7.0	0.048	15.6	555	0.01	0.15	2/3"	C
TCHR-15-110-S12 / C	1.5X	110	5.6	0.06	12.5	444	0.02	0.06	1/2"	C
TCHR-20-110 / C	2.0X	110	4.4	0.077	13	260	0.02	0.03	2/3"	C
TCHR-30-110 / C	3.0X	110	3.7	0.09	10.6	148	0.02	0.11	2/3"	C
TCHR-40-110 / C	4.0X	110	3.72	0.09	22.2	111	0.05	0.03	2/3"	C
TCHR-60-110 / C	6.0X	110	3.72	0.09	33.4	74	0.05	0.03	2/3"	C
TCHR-80-110 / C	8.0X	110	3.72	0.09	44.4	56	0.05	0.19	2/3"	C

I = Manual Iris, C = Coaxial, IC = Both / D.O.F Calculation: Permissible of circle of confusion : 40µm

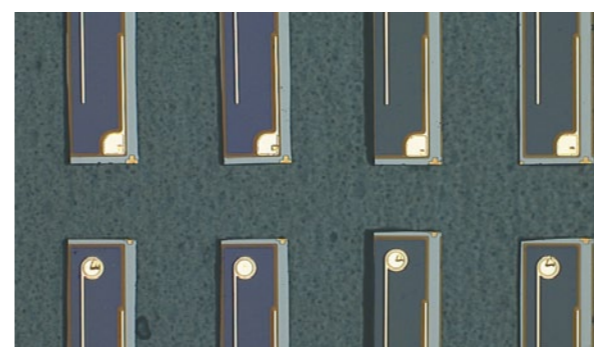

TCHR Series (WD: 130mm-190mm)

Lensagon No.	Mag.	WD	Res. (Obj.)	NA	F No.	D.O.F. (µm/mm)	Telecentricity (<degree)	Optical Distort. (%)	CCD size (max.)	Mount
TCHR-0165-130I	0.165X	130	28.2	0.012	7.1	20.8mm	0.017	0.13	1/2"	C
TCHR-023-130I	0.23X	130	20	0.016	7.1	10.7mm	0.01	0.13	2/3"	C
TCHR-03-130I	0.3X	130	17.6	0.019	7.9	7000	0.04	0.08	2/3"	C
TCHR-035-130I	0.35X	130	14.1	0.0238	7.3	4800	0.035	0.08	1/2"	C
TCHR-10-190I	1.0X	190	6.7	0.05	10	360	0.035	0.08	1/2"	C

I = Manual Iris, C = Coaxial, IC = Both / D.O.F Calculation: Permissible of circle of confusion : 40µm

S-Mount
C-Mount
Accessories
Telecentric
Line Scan
Macro
Illumination

Telecentric Lenses

Telecentric Lenses

TCST Series

Telecentric lens is good for the measurement without magnification change through over the D.O.F. and also good for even illumination (telecentric lighting) via coaxial illumination. We have several types of telecentric lenses like different working distance, magnification, CCD size & high resolution or standard resolution as follows.

- Fixed magnification lens
- Low optical distortion & good telecentricity
- High resolution and high contrast design
- Various W.D. & magnification
- Even coaxial illumination types

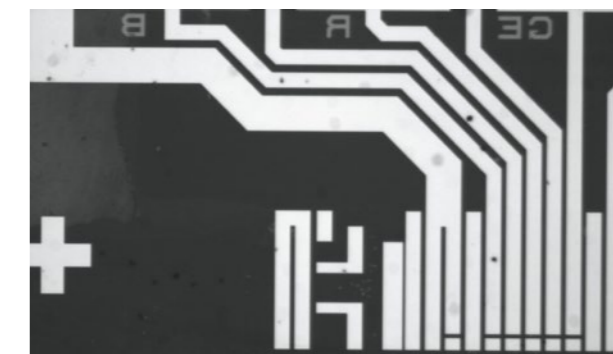
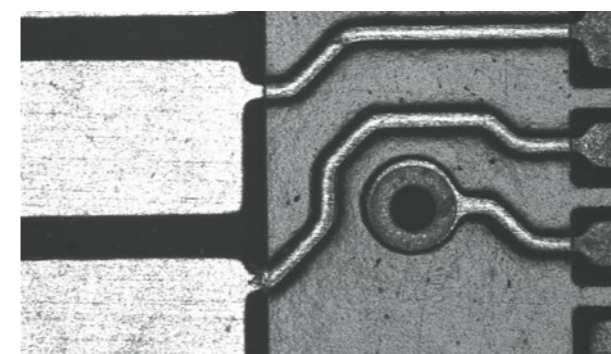

TCST Series (WD: 65mm)

NEW

Lensagon No.	Mag.	WD	Res. (Obj.)	NA	F No.	D.O.F. (μm)	Telecentricity (<degree)	Optical Distort. (%)	CCD size (max.)	Mount
TCST-05-65 / C	0.5X	65	20,2	0,017	15,0	4800	0,03	0,04	1/2"	C
TCST-08-65 / C	0.8X	65	12.4	0.027	14.8	1850	0.03	0.03	1/2"	C
TCST-10-65 / C	1.0X	65	12.4	0.027	18.5	1450	0.03	0.03	1/2"	C
TCST-15-65 / C	1.5X	65	7	0.048	15.6	554	0.05	0.06	1/2"	C
TCST-20-65 / C	2.0X	65	5.2	0.065	15.4	308	0.02	0.03	1/2"	C
TCST-30-65 / C	3.0X	65	4.8	0.07	21.5	191	0.02	0.16	1/2"	C
TCST-40-65 / C	4.0X	66	4.4	0.076	26.3	132	0.04	0.03	1/2"	C
TCST-50-65 / C	5.0X	65.5	4.4	0.076	32.9	105	0.04	0.05	1/2"	C
TCST-60-65 / C	6.0X	65.3	4.4	0.076	39.5	88	0.04	0.06	1/2"	C
TCST-80-65 / C	8.0X	64.9	4.4	0.076	52.6	66	0.05	0.05	1/2"	C

I = Manual Iris, C = Coaxial, IC = Both / D.O.F Calculation: Permissible of circle of confusion : 40μm

TCST Series (WD: 40mm)

Lensagon No.	Mag.	WD	Res. (Obj.)	NA	F No.	D.O.F. (μm)	Telecentricity (<degree)	Optical Distort. (%)	CCD size (max.)	Mount
TCST-05-40 / C	0.5X	43	11.2	0.03	8.3	2600	0.03	0.08	1/2"	C
TCST-10-40 / C	1.0X	40	6.21	0.054	9.26	740	0.03	0.08	1/2"	C
TCST-15-40 / C	1.5X	40	5.32	0.063	11.9	423	0.03	0.25	1/2"	C
TCST-20-40 / C	2.0X	40	4.8	0.07	14.28	286	0.03	0.03	1/2"	C
TCST-30-40 / C	3.0X	40	4.8	0.07	21.5	191	0.02	0.26	1/2"	C
TCST-40-40 / C	4.0X	40	4.8	0.07	28.6	143	0.02	0.2	1/2"	C
TCST-50-40 / C	5.0X	40	4.2	0.08	31.25	100	0.02	0.05	1/2"	C
TCST-60-40 / C	6.0X	40	4.2	0.08	37.4	83	0.02	0.02	1/2"	C
TCST-80-40 / C	8.0X	40	4.2	0.08	50	63	0.01	0.03	1/2"	C

I = Manual Iris, C = Coaxial, IC = Both / D.O.F Calculation: Permissible of circle of confusion : 40μm

TCST Series (WD: 110mm)

NEW

Lensagon No.	Mag.	WD	Res. (Obj.)	NA	F No.	D.O.F. (μm)	Telecentricity (<degree)	Optical Distort. (%)	CCD size (max.)	Mount
TCST-05-110 / C	0.5X	110	20.21	0.0166	15	4800	0.05	0.05	1/2"	C
TCST-08-110 / C	0.8X	110	12.4	0.027	14.8	1850	0.05	0.05	1/2"	C
TCST-10-113 / C	1.0X	113	14	0.024	20.8	1660	0.02	0.023	1/2"	C
TCST-12-110-S13 / C	1.0X	110	10,16	0,033	18	1000	0.03	0.03	1/3"(6mm)	C
TCST-20-110 / C	2.0X	110	7.4	0.045	22.2	444	0.02	0.02	1/2"	C
TCST-24-110 / C	2.4X	107	7.4	0.045	26.7	370	0.02	0.07	1/2"	C
TCST-30-110 / C	3.0X	110	6.1	0.055	27.3	243	0.01	0.14	1/2"	C
TCST-40-110 / C	4.0X	110	5.6	0.06	33.45	167	0.01	0.16	1/2"	C
TCST-50-110 / C	5.0X	110	5.6	0.06	41.77	134	0.01	0.14	1/2"	C
TCST-60-110 / C	6.0X	110	5.6	0.06	50	111	0.01	0.1	1/2"	C
TCST-80-110 / C	8.0X	110	5.6	0.06	66.7	85	0.015	0.25	1/2"	C

I = Manual Iris, C = Coaxial, IC = Both / D.O.F Calculation: Permissible of circle of confusion : 40μm

S-Mount
C-Mount
Accessories
Telecentric
Line Scan
Macro
Illumination

Telecentric Lenses

Telecentric Lenses

TCST Long WD Series

- Long working distance telecentric lenses. (up to 400mm)
- Good for the alignment application where long W.D is requested.
- 4 types of W.D (150, 220, 300, 400mm)
- Even-coaxial illumination on the whole area.
- High Resolution & low distortion



TCST Series (WD: 150-170mm)

Lensagon No.	Mag.	WD	Res. (Obj.)	NA	F No.	D.O.F. (μm/mm)	Telecentricity (<degree)	Optical Distort. (%)	CCD size (max.)	Mount
TCHR-01-150I	0.1X	150	40.4	0.0083	6	48mm	0.04	0.05	1/2"	C
TCST-08-173 / C	0.8X	173	11.2	0.03	13.3	1660	0.04	0.07	1/2"	C
TCST-10-156 / C	1.0X	156	8.8	0.038	13.1	1000	0.04	0.07	1/2"	C
TCST-12-173 / C	1.2X	173	11.2	0.03	20	1110	0.04	0.13	1/2"	C
TCST-15-156 / C	1.5X	156	8.83	0.038	19.7	700	0.04	0.16	1/2"	C
TCST-16-173 / C	1.6X	173	11.2	0.03	26.7	834	0.04	0.18	1/2"	C
TCST-20-156 / C	2.0X	156	8.83	0.038	26.3	526	0.04	0.19	1/2"	C

I = Manual Iris, C = Coaxial, IC = Both / D.O.F Calculation: Permissible of circle of confusion : 40μm

TCST Series (WD: 200-250mm)

Lensagon No.	Mag.	WD	Res. (Obj.)	NA	F No.	D.O.F. (μm)	Telecentricity (<degree)	Optical Distort. (%)	CCD size (max.)	Mount
TCST-075-220 / C	0.75X	220	8.9	0.0375	10	1400	0.03	0.08	1/2"	C
TCST-075-220-S23 / C	0.75X	220	9.1	0.037	10	1400	0.03	0.02	2/3"	C
TCST-10-220 / C	1.0X	220	7.4	0.045	11	880	0.03	0.01	2/3"	C
TCST-10-250-S118 / C	1.0X	250	7.45	0.045	11	484	0.03	0.081	1/1.8"	C
TCST-15-220-S12 / C	1.5X	220	7.45	0.045	16.6	590	0.03	0.13	1/2"	C
TCST-15-200 / C	1.5X	200	5	0.067	11.2	398	0.03	0.08	2/3"	C
TCST-20-200 / C	2.0X	200	4.2	0.08	12.5	250	0.03	0.02	1/2"	C
TCST-30-200 / C	3.0X	200	4.2	0.08	18.7	166	0.02	0.1	1/2"	C
TCST-40-200 / C	4.0X	200	4.19	0.08	25	125	0.015	0.13	1/2"	C

I = Manual Iris, C = Coaxial, IC = Both / D.O.F Calculation: Permissible of circle of confusion : 40μm



TCST Series (WD: 300mm)

Lensagon No.	Mag.	WD	Res. (Obj.)	NA	F No.	D.O.F. (μm)	Telecentricity (<degree)	Optical Distort. (%)	CCD size (max.)	Mount
NEW TCST-08-320 / C	0.8X	320	11.98	0.028	14.0	1750	0.03	0.03	1/2"	C
TCST-10-300 / C	1.0X	300	9.6	0.035	14.2	1100	0.02	0.03	1/2"	C
NEW TCST-10-340 / C	1.0X	340	38.56	0.04	12.5	1000	0.03	0.04	1/2"	C
TCST-15-300 / C	1.5X	300	9.6	0.035	21.4	762	0.02	0.13	1/2"	C
TCST-20-300 / C	2.0X	300	9.6	0.035	28.5	571	0.01	0.17	1/2"	C

I = Manual Iris, C = Coaxial, IC = Both / D.O.F Calculation: Permissible of circle of confusion : 40μm



TCST Series (WD: 400mm)

Lensagon No.	Mag.	WD	Res. (Obj.)	NA	F No.	D.O.F. (μm)	Telecentricity (<degree)	Optical Distort. (%)	CCD size (max.)	Mount
TCST-05-400 / C	0.5X	402	12.9	0.026	9.6	3.07mm	0.03	0.05	1/2"	C

I = Manual Iris, C = Coaxial, IC = Both / D.O.F Calculation: Permissible of circle of confusion : 40μm

S-Mount
C-Mount
Accessories
Telecentric
Line Scan
Macro
Illumination

Telecentric Lenses

Telecentric Zoom Lenses

Features

- Telecentricity at any magnification
- Suitable for high resolution megapixel cameras
- Magnification can be converted from 0.25 x to 2.6x by using front converter
- Less shading and keeps uniformity of intensity
- TV distortion less than 0.01%



Lensagon No.	Mag.	WD	Depth of Field	Resolution	NA	CCD	Mount
TZ0510	0.5x-1.0x	174mm-114mm	1.20mm-0.47mm	12.5µm-9.8µm	0.066-0.085	2/3"	C
TZ0513	0.5x-1.3x	173mm-97mm	1.84mm-0.52mm	8µm-6.4µm	0.044-0.059	2/3"	C

Values when the converter is attached to TZ0513:

Lensagon No.	Mag.	WD	Application
FC02510	0.25x-1.0x	323.2mm-115.6mm	Front converter for TZ0513
FC1426	1.4x-2.6x	56.2mm-42.6mm	Front converter for TZ0513

Depth of field is calculated assuming a horizontal 320 TV resolution using 1/2" CCD camera (permissible circle of confusion, 40µ)

Sensor Size Extender

When this extender is mounted between a lens and CCD camera, the magnification can be doubled without changing the working distance.

The advantage of our RCN15 and RCN20 is that they make the FOV stay constant, while the image circle enlarges. For example RCN20 on 1/2" sensor will work like a 1" sensor.



RCN20

RCN15

Lensagon No.	Magnification	Mount
RCN15	1.5x	C-Mount
RCN20	2.0x	C-Mount

Telecentric Linescan Lenses

TL4K Series 4K Line CCD's Telecentric Lens

- We have several telecentric lenses for 4K line CCD camera.(7µm/Pixel)
- High accuracy lens for 4K line CCD camera.
- Very good telecentricity and high contrast image.
- Low distortion over the whole field of view.
- IRIS diaphragm for adjusting D.O.F.
- Object-side telecentric lens



Lensagon No.	Mag.	WD	Res. (Obj.)	NA	F No.	D.O.F. (µm)	Telecentricity (<degree)	Optical Distort. (%)	CCD size (max.)	Mount
TL4K-05-237I	0.5X	237	8.4	0.04	6.25	700	0.02	0.08	4K(7µm)	F
TL4K-07-130I	0.7X	130	5.1	0.066	5.3	303	0.04	0.05	4K(7µm)	F
TL4K-077-140I	0.77X	140	7	0.0477	8	544	0.03	0.06	4K(10µm)	M72
TL4K-092-170I	0.92X	170	5.2	0.064	7.14	250	0.01	0.03	4K(7µm)	F
TL4K-10-138I	1.0X	138	6.1	0.055	9.1	364	0.04	0.02	4K(10µm)	F
TL4K-20-102	2.0X	102	3.7	0.09	11.1	111	0.03	0.07	4K(10µm)	F

I = Manual Iris, C = Coaxial, IC = Both / Possible to change mount

S-Mount
C-Mount
Accessories
Telecentric
Line Scan
Macro
Illumination

Telecentric Linescan Lenses

TL8K Series 8K Line CCD's Telecentric Lens

- High accuracy lens for 8K line CCD camera.
- Very good telecentricity and high contrast image.
- Low distortion over the whole field of view.
- Uniform coaxial illumination with LED coaxial guide.
 - Provides easy alignment with CCD camera and illumination.
 - Inner coaxial illumination, not external coaxial illumination.
- Good for 8K TDI & general line CCD



Lensagon No.	Mag.	WD	Res. (Obj.)	NA	F No.	D.O.F. (μm)	Telecentricity (<degree)	Optical Distort. (%)	CCD size (max.)	Mount
TL8K-0467-278 / C	0.467X	278	12	0.028	8	1000	0.04	0.03	8K(7μm)	M72

TL12K Series 12K Line CCD's Telecentric Lenses



- High resolution & High contrast optical design.
- Can be applied from 8K to 12K line CCD.
- Almost perfect telecentric design. (telecentricity: < 0.04 degree)
- Low distortion over the whole field of view.
- Support upto 5um/pixel (12K Line CCD)
- Uniform coaxial illumination with LED coaxial guide.
 - Provides easy alignment with CCD camera and illumination.
 - Inner coaxial illumination, not external coaxial illumination.

Lensagon No.	Mag.	WD	Res. (Obj.)	NA	F No.	D.O.F. (μm)	Telecentricity (<degree)	Optical Distort. (%)	CCD size (max.)	Mount
TL12K-064-170I	0.64X	170	8.4	0.04	8	390	0.04	0.06	12K(5μm)	M72
TL12K-07-117I	0.7X	117	7.7	0.044	8	326	0.04	0.07	12K(5μm)	M72
TL12K-07-145 / C	0.7X	145	10,16	0,033	10,6	450	0,04	0,03	12K(5μm)	M72
TL12K-087-137I	0.87X	137	6.5	0.052	8.3	219	0.04	0.07	12K(5μm)	M72
TL12K-10-122 / C	1.0X	122	6.7	0.05	10	200	0.04	0.02	12K(5μm)	M72
TL12K-20-107I	2.0X	107	3.9	0.085	11.8	59	0.04	0.03	12K(5μm)	M72
TL12K-35-78 / C	3.5X	78	3.05	0.11	15.9	25.9	0.04	0.05	12K(5μm)	M72
TL12K-50-78/C	5.0X	78	2.58	0.13	19.2	15.2	0.04	0.08	12K(5μm)	M72
TL12K-70-15 / C	7.0X	15	1.5	0.23	15.2	62	0.03	0.32	12K(5μm)	M72
TL12K-100-13/C	10.0X	13.5	1.68	0.2	25	5	0.04	0.02	12K(5μm)	M72

NEW

Linescan Lenses

Line Scan Lenses for Wide Field of View

Our large format lens series has been specifically designed for the line-scan and large area sensor market. Covering up to 62mm sensors, these low distortion lenses are ready for challenging applications.

Features:

- Working distance and magnification are adjustable
- Suitable for long working distance
- Designed for machine vision application
- FLS8528 is compatible with M72 mount
- Suitable for various applications such as printing, PC, glass, textile etc..



Lensagon No.	F No.	Focal length	Range of WD	Magnification	Distortion	Max. comp. CCD	Mount
FLS2528	2.8	25mm	140mm ~ ∞	0.15x	0.66%	Ø 44mm	F
FLS3528	2.8	35mm	230mm ~ ∞	0.15x	-0.31%	Ø 44mm	F
FLS5026	2.6	50mm	0.32m ~ ∞	0.18x	0.23%	Ø 45mm	F
FLS5014HS	1.4	50mm	0.27m ~ ∞	0.2x	0.17%	Ø 45mm	F
FLS5028CW	2.8	50mm	190mm ~ ∞	0.3x	-0.40%	Ø 44mm	F
FLS8528	2.8	85mm	0.46m ~ ∞	0.2x	0.04%	Ø 62mm	F or M72

Indicated specifications are design values

FLS2528

FLS3528

FLS5026

FLS5014HS

FLS5028CW

FLS8528

Linescan Lenses

Macro Zoom Lenses

LS-12K Series: Line Scan Lenses for 8K to 12K line CCD

WD 50 mm - 320 mm

Lensagon No.	Mag.	WD	D.O.F	Res. (Obj.)	NA	CCD size	F No.	Optical Distortion (%)	Mount
LS-05-330I-12K	0.5X	330 mm	512	8.6 μm	0.039	12k (5u)	6.4	0.08	M57
LS-07-257I-12K	0.7X	257 mm	408	9.6 μm	0.035	12k (5u)	10	0.01	M47
LS-10-202I-12K	1.0X	202 mm	100	6.7 μm	0.05	12k (5u)	10	0.04	M47
LS-14-168I-12K	1.4X	168 mm	113	5.4 μm	0.063	12k (5u)	11.1	0.02	M47
LS-20-50I-12K	2.0X	50 mm	45	3.1 μm	0.11	12k (5u)	9.1	0.03	M47
LS-20-140I-12K	2.0X	140 mm	64	4.3 μm	0.078	12k (5u)	12.8	0.03	M57
LS-35-88I-12K	3.5X	88 mm	41	2.4 μm	0.14	12k (5u)	12.5	0.05	M47

Possible to change mount

- High resolution & high contrast optical design
- Can be applied from 8K to 12K line CCD
- Low distortion for excellent image quality
- Large imluge circle up to 61.4mm(12K @ 5um)
- Magnification varies from 0.5X to 3.5X

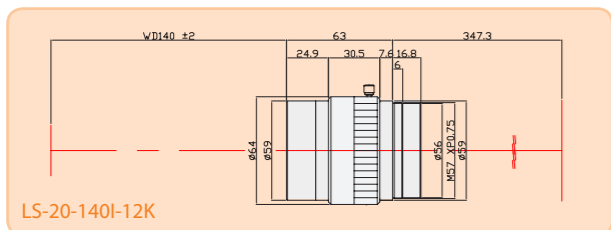
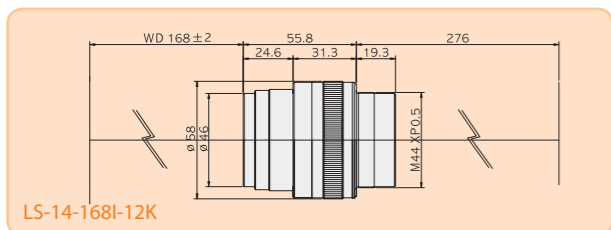
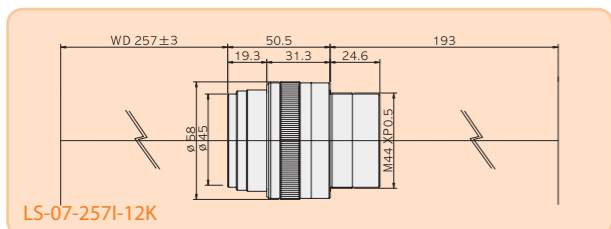
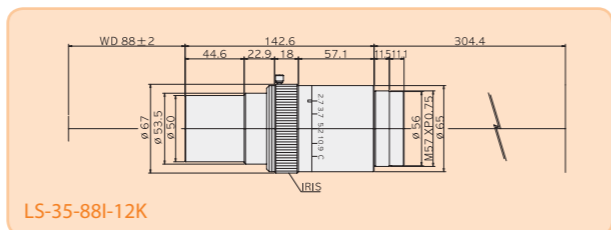
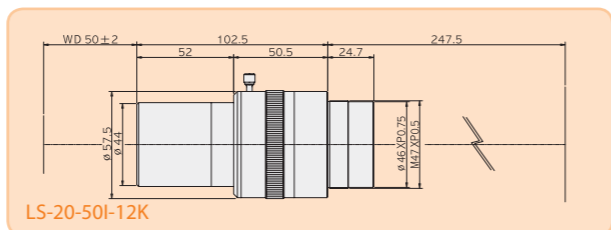
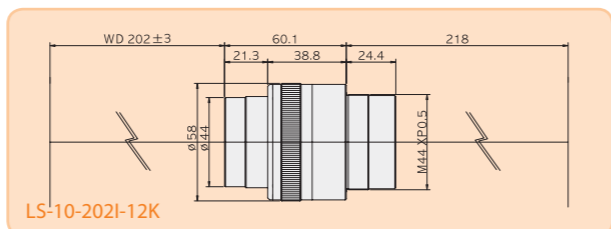
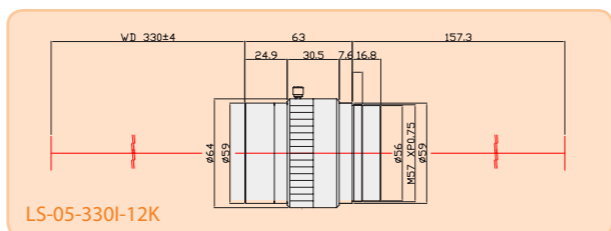

Macro Zoom Lens

Lensagon No.	Mag.	WD	Resolution (μm)	NA	F/#	D.O.F. (μm)	Optical Distort. (%)	CCD size (max.)	Mount
MZC0515	0.5X	184	11.25	0.0298	8.3	2600	0.2	1/2"	C
	1.5X	184	6.7	0.05	15	533	0.15	1/2"	
MZC0530S12	0.5X	180	21	0.016	15.6	4990	0.6	1/2"	C
	3.0X	180	7.8	0.043	34.9	310	0.2	1/2"	
MZC0530S13	0.5X	180	18.6	0.018	13.9	4450	0.25	1/3"	C
	3.0X	180	7	0.048	31.3	278	0.14	1/3"	

- This zoom lens has high resolution to get high contrast image compared to the general zoom lens.
- Magnification ranges: 0.5 ~ 1.5X, 0.5X ~ 3.0X
- W.D: 184mm, 180mm
- Support upto 1/2" or 1/3" CCD camera
- Fine focus adjustment

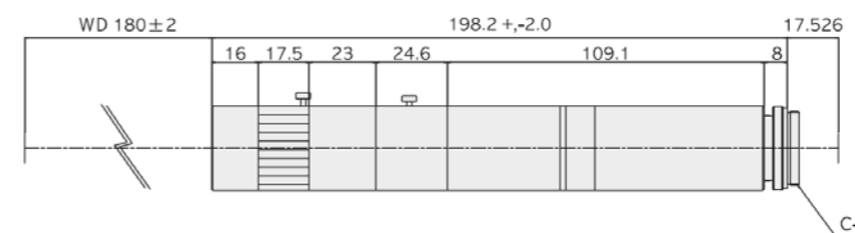
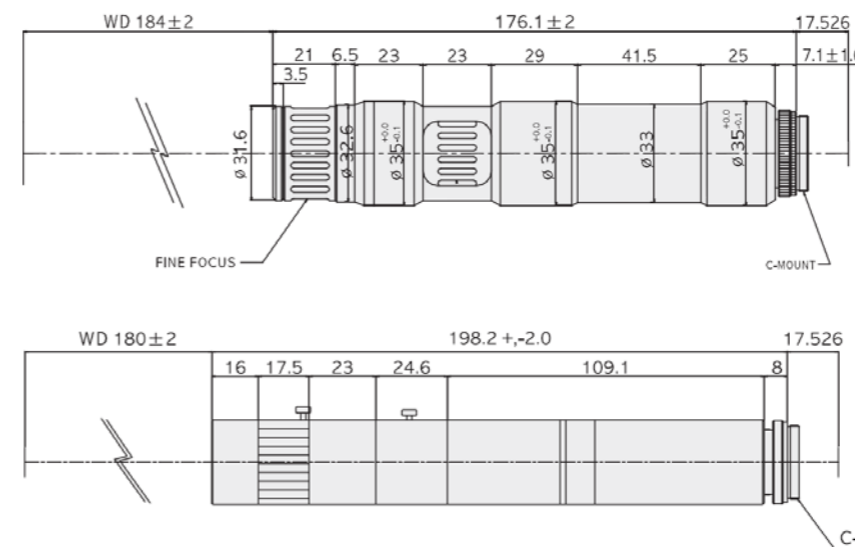

Lensagon No.	Mag.	WD	Resolution (μm)	NA	F/#	D.O.F. (μm)	Optical Distort. (%)	CCD size (max.)	Mount
MZ3050	3.0X	38	3.6	0.093	16.1	93.6	0.046	2K(13u)	M42
	4.0X	38	2.92	0.115	17.4	56.5	0.032	2K(13u)	
	5.1X	38	2.6	0.13	19.6	39.1	0.044	2K(13u)	

- This zoom lens is designed specially for large CCD cameras like 2K Line CCD, 4M CCD cameras, etc
- This lens also has the high resolution and low distortion for over full range of magnification
- IRIS diaphragm adapted 26mm diagonal

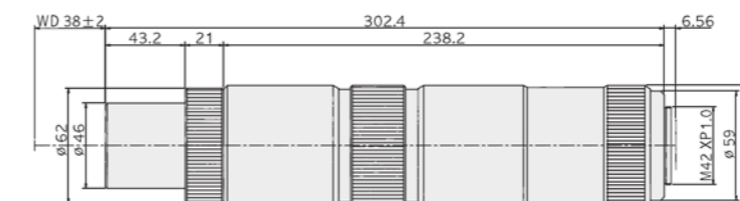

Macro Zoom Lenses

Macro Lenses

MCV5M Varifocal Macro Zoom Lens

Lensation presents the classy new MCV5M, a variable 5-Megapixel macro lens. It is particularly characterised by its excellent image quality at a very high depth of field.

The easy-to-use locking mechanism allows freely adjustable magnification. This alleviates the need for system vendors to keep a larger selection of lenses with a fixed setting in stock continuously. A special highlight is the near distortion-free optics, which makes the MCV5M ideal for use in precise measuring applications. Our new C-Mount lens is suitable for 1/2.5" sensors (max. 2/3") and provides magnification from 0.58x at 146mm working distance (WD) to 1.725x at 75mm WD.

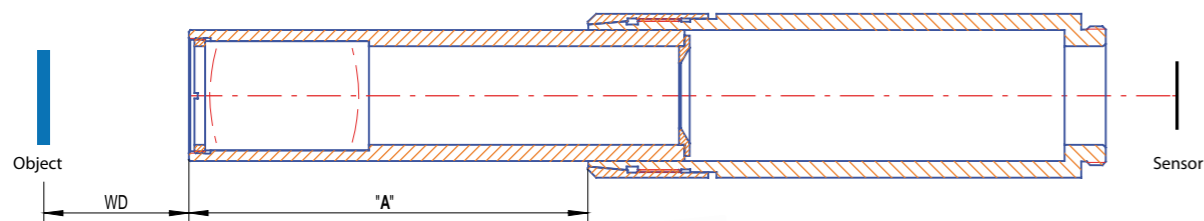

For more information and instructions on how to calculate the working distance, please visit our website and click on "download data sheet":

www.lensation.de/mcv5m

Macro Lenses

These series are non-telecentric lenses for machine vision applications like factory automation. For many types of CCD cameras like 1/2", 2/3", 2M, 4M, 5M, 8M, 12M & 15M, with high resolution and low distortion quality.

Features:

- Various working distance and magnification
- Fixed magnification (can be modified to another magnification)
- Mount: C-mount, F-mount & M48-P0.75
- IRIS diaphragm adapted (some lenses)



Standard

Lensagon No.	Mag.	WD	Res. (Obj.)	NA	F No.	D.O.F. (µm/mm)	Optical Distort. (%)	CCD size (max.)	Mount
MCST-034-120	0.34X	120	15.80	0.0212	8.00	5500	0.07	1/2"	C
MCST-053-110	0.53X	110	11.18	0.0300	9.00	2560	0.06	1/2"	C
MCST-06-117	0.6X	117	9.30	0.0360	8.30	1800	0.02	1/2"	C
MCST-06-120	0.6X	120	9.30	0.0360	8.30	1800	0.04	1/2"	C
MCST-08-100	0.8X	100	8.20	0.0410	9.70	1200	0.03	1/2"	C
MCST-12-100	1.2X	100	7.80	0.0430	13.90	772	0.03	1/2"	C
MCST-20-100	2.0X	100	7.10	0.0470	21.20	424	0.04	1/2"	C
MCST-40-92	4.0X	92	6.10	0.0550	36.40	180	0.01	1/2"	C
MCST-019-240	0.19X	240	28.00	0.0120	7.77	17 mm	0.13	2/3"	C
MCST-03-240	0.3X	240	17.66	0.0190	7.80	6900	0.135	2/3"	C
MCST-057-200	0.57X	200	11.57	0.0290	10.00	2460	0.04	2/3"	C

D.O.F. Calculation: Permissible of circle of confusion : 40µm

For 2 Megapixel sensors

Lensagon No.	Mag.	WD	Res. (Obj.)	NA	F No.	D.O.F. (µm)	Opt. Distort. (%)	CCD size (max.)	Mount
MC2M-0198-185	0.198X	185	21.20	0.0158	6.25	9570	0.06	1/1.8"	C
MC2M-025-194I	0.25X	194	8.50	0.0395	3.16	3030	0.01	2M	C
MC2M-047-176	0.47X	176	10.17	0.0330	7.14	1900	0.28	2M	C
MC2M-055-164	0.55X	164	9.80	0.0342	8.10	2100	0.06	2M	C
MC2M-05-253	0.5X	253	11.18	0.0300	8.33	2000	0.06	2M	C
MC2M-075-164	0.75X	164	8.90	0.0376	10.00	1070	0.06	2M	C

D.O.F. Calculation: Permissible of circle of confusion : 30µm

S-Mount
C-Mount
Accessories
Telecentric
Line Scan
Macro
Illumination

Macro Lenses



For 4 Megapixel sensors

Lensagon No.	Mag.	WD	Res. (Obj.)	NA	F No.	D.O.F. (μm/mm)	Opt. Distort. (%)	CCD size (max.)	Mount
MC4M-0185-225I	0.185X	225	18.10	0.0185	5.00	8770	0.01	4M	C
MC4M-0215-226I	0.215X	226	20.00	0.0170	6.25	8120	0.01	4M	C
MF4M-0247-267	0.247X	267	13.60	0.0247	5.00	4900	0.01	4M	F
MC4M-025-194I	0.25X	194	14.80	0.0230	5.50	5280	0.01	4M	C
MF4M-037-261	0.37X	261	9.10	0.0370	5.00	2190	0.01	4M	F
MF4M-055-210	0.55X	210	10.20	0.0330	8.30	1650	0.04	4M	F
MF4M-075-193	0.75X	193	8.90	0.0376	10.00	1060	0.06	4M	F
MC4M-015-255I	0.15X	255	29.8	0.01125	6.7	17.87mm	0.08	4M	C
MF4M-0296-267	0.296X	267	12	0.028	5.3	3600	0.01	4M	F
MC4M-03-170I	0.3X	170	17.2	0.02	7.7	5130	0.06	4M	C
MF4M-043-261	0.43X	261	7.8	0.043	5	1620	0.01	4M	F
MF4M-063-310I	0.63X	310	6.9	0.0485	6.5	983	0.08	4M	F
MF4M-074-247	0.74X	247	6.5	0.0518	7.1	778	0.06	4M	F

D.O.F Calculation: Permissible of circle of confusion : 30μm

For 5 Megapixel sensors

Lensagon No.	Mag.	WD	Res. (Obj.)	NA	F No.	D.O.F. (μm)	Opt. Distort. (%)	CCD size (max.)	Mount
MC5M-019-240	0.19X	240	17.70	0.0190	5.00	5500	0.03	2/3"	C
MC5M-0257-185	0.257X	185	16.80	0.0200	6.25	3800	0.01	2/3"	C

D.O.F Calculation: Permissible of circle of confusion : 20μm

For 8 Megapixel sensors

Lensagon No.	Mag.	WD	Res. (Obj.)	NA	F No.	D.O.F. (μm)	Opt. Distort. (%)	CCD size (max.)	Mount
MF8M-035-300	0.35X	300	9.6	0.035	5.00	2400	0.08	8M (23mm)	F
MF8M-05-300	0.5X	300	6.7	0.05	5.00	1200	0.08	8M (23mm)	F
MF8M-08-260	0.8X	260	5.9	0.0568	7.00	660	0.05	8M (23mm)	F

D.O.F Calculation: Permissible of circle of confusion : 20μm

For 12 Megapixel sensors

Lensagon No.	Mag.	WD	Res. (Obj.)	NA	F No.	D.O.F. (μm)	Opt. Distort. (%)	CCD size (max.)	Mount
MD12M-054-235I	0.54X	235	7.80	0.0430	6.25	1280	0.05	12M	M48

D.O.F Calculation: Permissible of circle of confusion : 30μm

For 15 Megapixel sensors

Lensagon No.	Mag.	WD	Res. (Obj.)	NA	F No.	D.O.F. (μm)	Opt. Distort. (%)	CCD size (max.)	Mount
MF15M-042-300	0.42X	300	8.6	0.039	5.37	1200	0.08	15M	F
MF15M-0789-260	0.789X	260	5.95	0.056	7	674	0.06	15M	F

D.O.F Calculation: Permissible of circle of confusion : 20μm

LED Illumination

Coxial LED Illumination

LED illumination is more popular in machine vision application instead of Halogen source by means of the life time and compact size. The brightness of LED is increasing so fast. Therefore most of application in machine vision illumination can be covered by LED illumination.

- Ultra high bright spot illumination
- Enough for coaxial illumination of most of the telecentric lens
- High contrast compared to halogen source
- Long lifetime and low power consumption
- Several illumination colors(R, G, B, White)
- 4 type's coaxial LED guide(5mm dia, 1W, 3W, 5W)

Lensagon No.	Color	Power Consumption
LED-CX-5D	W,R,G,B	-
LED-CX-1W	W,R,G,B	1W
LED-CX-3W	W,R,G,B	3W
LED-CX-5W	W,R,G,B	5W
LED-SP-1W	W,R,G,B	1W
LED-SP-3W	W,R,G,B	3W



LED-CX-5D

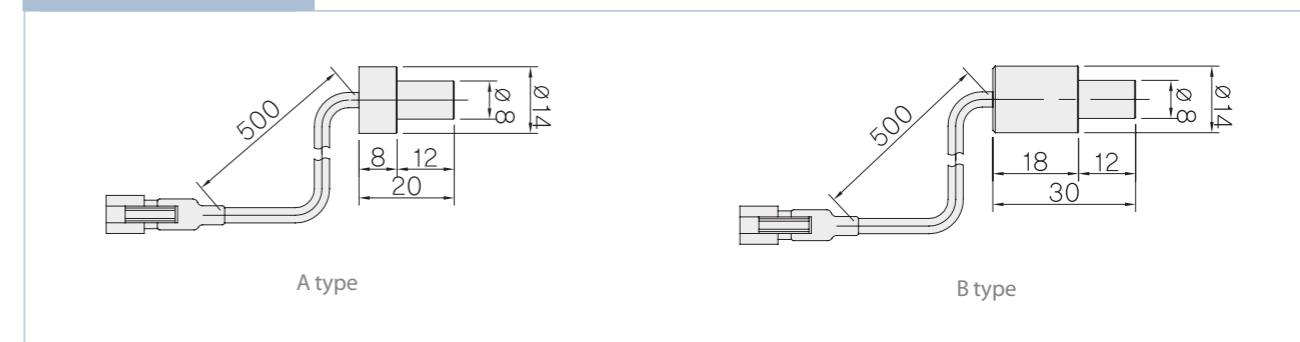

LED-CX-1W

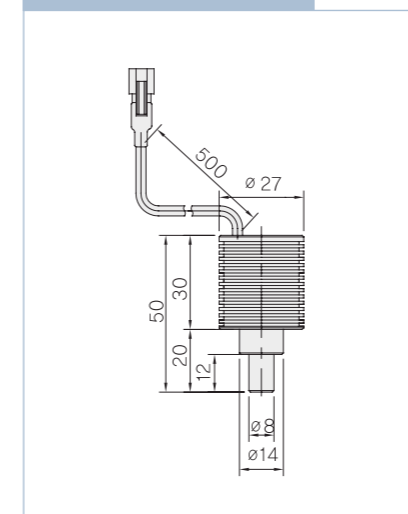

LED-CX-3W/5W

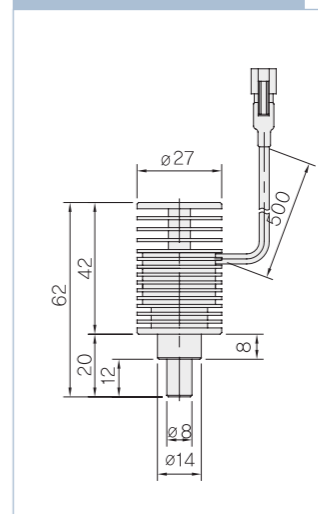

LED-SP-1W/3W

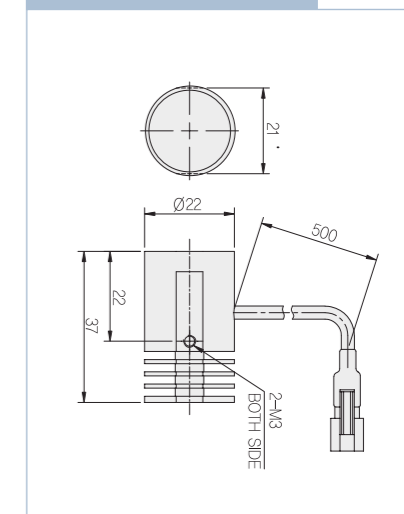

S-Mount
C-Mount
Accessories
Telecentric
Line Scan
Macro
Illumination

Analog LED Controller

It can control the LED guide which is commonly used in machine vision.
It is constant current control type instead of voltage control.

- Basic channel: 2 up to 9channel
- Constant current control type optimized for LED lamp
- External 0~5V voltage to control the volume
- On/Off control by DC voltage (Ex, Off@ 5V)



Lensagon No.	Channel	Output	Volume Control	Input Voltage	RC Connector
LED-CONT-2CA	2	700mA@5V or 12V (max : 24W)	Volume control by front knob	AC 100 ~240V/50/60Hz	D-Sub. 15-pin (male)
LED-CONT-4CA	4	700mA@5V or 12V (max : 50W)	Volume control by front knob	AC 100 ~240V/50/60Hz	D-Sub. 15-pin (male)
LED-CONT-9CA	9	1.2A @40V (max : 500W)	Volume control by front knob	AC 220V±15%	D-Sub. 15-pin (male)

Digital LED Controller

This controller is digital control type instead of analog via RS-232 communication to give customers convenient.

- Basic channel: 2 up to 8channel
- Constant current control type optimized for LED lamp
- Rs-232 communication control for volume
- I/O control for On/Off function
- Volume display on the front panel of the controller



Lensagon No.	Channel	Output	Volume Control	Input Voltage	RC Connector
LED-CONT-2CD	2	700mA@5V or 12V (max : 50W)	0-255 level by Jog Dial	AC 100 ~240V/50/60Hz	RS-232 D-Sub 15pin (male)
LED-CONT-4CD	4	700mA@5V or 12V (max : 50W)	0-255 level by Jog Dial	AC 100 ~240V/50/60Hz	RS-232 D-Sub 15pin (male)
LED-CONT-8CD	8	700mA@5V or 12V (max : 100W)	0-255 level by Jog Dial	AC 220V±15%	RS-232 D-Sub 15pin (male)

Optical Glossary

Resolution(μm)

Resolution is a measure of how closely spaced two points may be before they cannot be distinguished. For example, 1μm resolution means that two points that are 1μm away from each other can be distinguished. Resolution values in this catalog are lenses' theoretical resolutions. The following is a formula to calculate theoretical resolution based on an aplanatic lens's ray diffraction. (Rayleigh formula) $Wavelength \times 0.61 \times NA$

Resolving power(line/mm)

Resolving power indicates the number of black and white lines distinguished within 1mm in an image through a black and white grid-like chart lens. It is expressed by line/mm. For example, 100 line/mm means that black and white pitch 1/100mm(10μ) can be distinguished. The width of both the black and white lines is 1/200mm(5μ).

Horizontal TV resolution

The total number of black and white horizontal stripes on a TV monitor screen. It is expressed in TV lines. For example, 200TV lines of horizontal TV resolution means that 100 white horizontal lines is counted as one line. However, for TV lines, one pair is counted as 2 TV lines. For example, if a 1/2-inch CCD camera is used with a lens of 50 lines/mm resolving power, horizontal TV resolution on a TV monitor screen is calculated as follows; $50 \times 6.4(\text{CCD width}) \times 2 = 640\text{TV}$

Distortion

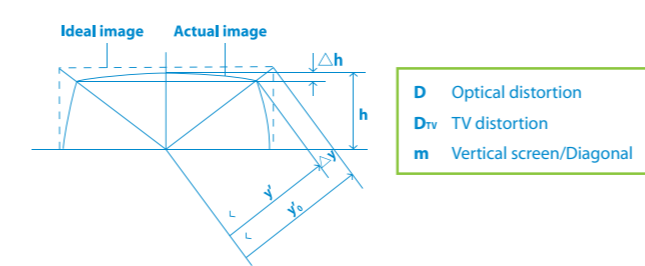

Optical distortion
Lens's aberration where a straight object outside of the optical axis appears curved.

$$\frac{y' - y'_0}{y'_0} \times 100\%$$

Positive distortion of a straight line is called pincushion distortion. Negative distortion is called barrel distortion.

TV distortion
Image distortion on a TV monitor. The closer to zero, the better the performance.

$$D_{TV} = \frac{\Delta h}{2h} \times 100\% \quad D_{TV} = \frac{1}{2} (1 - m^2) D \quad m = 0.6 \quad D_{TV} = 0.32D$$

Object	Pincushion distortion	Barrel distortion

Aperture efficiency / Marginal light quantity (%)
Aperture efficiency indicates the brightness difference between the optical axis of the image formation plane and its surrounding area when an evenly bright object is captured with a lens. It is expressed by percent(%) assuming that the center brightness is 100. It is one of a lens's optical characteristics.

Shading

Shading is the brightness difference between TV monitor's center and its edges when an evenly bright object is captured with a lens and CCD-TV camera. Shading indicates comprehensive performance of a lens and TV camera.

Chromatic aberration

In lenses' optional systems, positions where images are formed and image magnification differ according to light's wavelength. Rays with different wavelengths have different colors. This is called chromatic aberration. Aberration on the optical axis is called chromatic aberration on the axis and magnification difference is called magnification chromatic aberration.

F Number (F No)

The value indicates a lens's brightness. It is calculated by dividing the lens's focal length by the lens's effective diameter(entrance pupil D mm) looking from object side. It can be also calculated by NA and lens's optical magnification(.). The smaller the number, the brighter the lens is. $F No = f/D$

Effective F No

The value indicates a lens's brightness. It is calculated by dividing the lens's focal length by the lens's effective diameter(entrance pupil D mm) looking from object side. It can be also calculated by NA and Lens's optical magnification(.). The smaller the number, the brighter the lens is. $Effective F No = (1+M) \times F No$

Numerical aperture

The higher the NA, the greater the resolution and brightness are. When the half angle that an image makes on exit pupil is u' and refractive index is n' , $n' \times \sin u'$ is called image side numerical aperture, NA'. NAs in this catalog indicate object side numerical apertures.

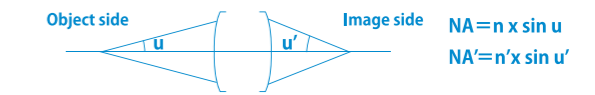

$NA = M/2 \times F, NA' = 1/2 \times F$
Relation of NA and NA' is $NA = NA' \times \text{Optical magnification}$ or $NA' = NA / \text{optical magnification}$.

MTF

It provides a graph analyzing a lens' ability to resolve sharp details in very fine sets of parallel lines, and a lens' contrast or ability to provide a sharp transfer between light and dark areas in sets of thicker parallel lines.

Depth of field

Images through lenses theoretically form as points. Acceptable blur on an acceptably clear image is called the permissible circle of confusion. Depth is the distance between the nearest and farthest points that appear in acceptably sharp focus when an object is shifted back and force from the best focal point. Depth range of the object side is called depth of field.
 $Depth of field = 2(\text{Permissible circle of confusion} \times \text{Effective F No} / \text{Magnification}^2)$

Depth of focus

Depth is the distance between the nearest and farthest points that appear in acceptably sharp focus when a CCD is shifted back and force from the best focal point. Depth range of the image side is called depth of focus.

Angle of view

The angle formed by imaginary lines connecting the lens second principal point with both ends of the image diagonal. Angle of view is directly associated with lens focal length. As the focal length is longer, the angle of view is narrower.
 $Angle of view = 2 \times \tan^{-1} (Image size / 2f \text{ Focal length})$

WD

Distance from the front end of a lens system to the object under inspection.

OI

Distance from the object to the image sensor.

Focal length

Focal length is the distance from the optical system's principle point to the focal point. Distance from the vertex of the last lens to the back focal point is called back length. Distance from the vertex of the first lens to the front focal point is called front focal length.

Image size

The diameter of the sharp image circle formed by a lens. Area sensor is expressed by inch, and diameter of image circle is equal to diagonal of sensor. Image circle of diameter for line sensor is equal to the maximum sensor size. It is expressed by pixel size x resolution.

Optical Formulas

How to calculate optical magnification

Most of Lensagon lens series are designed at finite distance. Optical magnification is the image size (CCD) ratio against the object size (FOV) and the most important for selection of a lens.

CCD size

Area CCD

Examples of area CCD used for machine vision. It is expected that various CCD will be available for next generation.

Image Size inch	1/4	1/3	1/2	1/1.8	2/3	1	1.1
Vertical mm	2.7	3.6	4.8	5.35	6.6	9.6	12
Horizontal mm	3.6	4.8	6.4	7.14	8.8	12.8	12
Diagonal mm	4.5	6	8	8.93	11	16	17

Line CCD

Length of line sensor is formed, depended on pixel size and resolution. As the line CCD is larger, the dimension of a lens becomes larger. Design and manufacture of lenses for the large line CCD are required for high specification.

Image Size mm	10.24	14.34	20.48	28.67	28.67	35	36	57.34	61.44
Pixel size μm	10	14	10	14	7	4.7	7	7	5
Resolution pixel	1024	1024	2048	2048	4096	7450	5150	8192	12288

Formula of optical magnification

FOV

Field of view (FOV) The actual size of a viewed object that can be taken when the lens is attached to the camera.
Ex. Optical magnification: 0.5x CCD: 1/2

Vertical FOV $4.8 \div 0.5$ 9.6mm Horizontal FOV $6.4 \div 0.5$ 12.8mm

Magnification

Optical magnification (M) = CCD size/FOV

$$M = \frac{y'}{y} = \frac{b}{a}$$

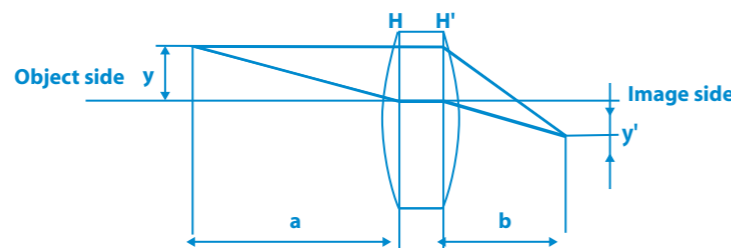

Electronic magnification and monitor magnification

Electronic magnification

Magnification of an image on a CCD camera when it is displayed on a monitor screen.

Monitor magnification

Magnification of an object displayed on a monitor screen through a lens.

Ex. Optical magnification: 0.5x CCD: 1/2 Monitor size: 15 inch (1 inch = 25.4mm)

Electronic magnification $15 \times 25.4 \div 8$ 47.6x

Monitor magnification 0.5×47.65 23.8x

How to calculate focal length and photographic range

Formula of photographic range

$$X = \frac{\text{Distance from lens to object} \times \text{Image size}}{\text{Focal length}}$$

Ex. Object distance: 100mm Focal length: 50mm CCD: 2/3

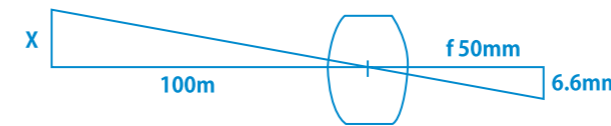

$$X = \frac{100,000 \times 6.6}{50} = 13,200 \text{ (mm)} \quad \text{Height: 13.2m}$$

Formula of Focal length

$$f = \frac{\text{Distance from lens to object} \times \text{Image size}}{\text{Height}}$$

Ex. Object distance: 20m Height: 6.6m CCD: 2/3

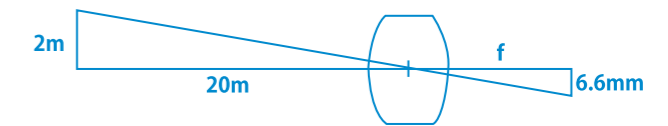

$$f = \frac{20,000 \times 6.6}{2,000} = 66 \text{ (mm)} \quad \text{Focal length: 66mm}$$

Formula of conjugation relationship

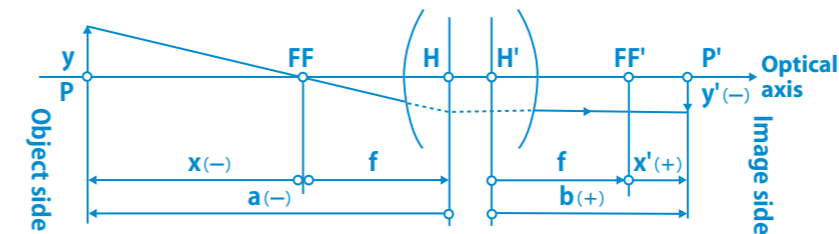

Basics formula

$$-\frac{1}{a} + \frac{1}{b} = \frac{1}{f}$$

Horizontal magnification

$$M = \frac{y'}{y} = \frac{b}{a}$$

Object point distance

$$-a = \left(1 - \frac{1}{M}\right) \times f$$

Image point distance

$$b = (1 - M) \times f$$

f : Focal length

FF : Front side focal point

FF' : Rear side focal point

H : Front side principal point

H' : Rear side principal point

P : Object point

P' : Image point

a : Distance from front side point to object point

b : Distance from rear side principal point to image point

x : Distance from front side focal point to object point

x' : Distance from rear side focal point to image side point

M : Magnification

F No./NA Formula

Relationship of object side NA and image side NA (NA') $NA' = \frac{NA}{M}$

Relationship of NA and Effective F No.

$$NA' = \frac{1}{2Fe} \quad NA' = \frac{1}{2(1-M)F}$$

Relationship of F No. and Effective F no.(Ef) $Fe = (1-M)F$

$$NA = \frac{M}{2Fe} \quad NA = \frac{M}{2(1-M)F}$$

Camera mount and flange back

Back focus

Distance from the vertex of the last lens to the back focal point.

Flange back

Distance from the camera's lens mount reference surface to the focal plane.

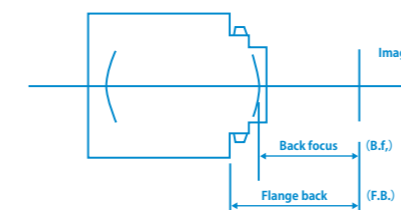

Name	Flange back	Screw size
C Mount	17.526mm	25.4mm 32tpi thread
CS Mount	12.5mm	25.4mm 32tpi thread
F Mount	46.5mm	Bayonet
K Mount	45.5mm	Bayonet

Field of View Table

M.M. = Monitor Magnification (14" monitor)

	1"		2/3"		1/2"		1/3"		1/4"	
	HxWxD	M.M.	HxWxD	M.M.	HxWxD	M.M.	HxWxD	M.M.	HxWxD	M.M.
0.1x	96x128x160	2.3x	66x88x110	3.3x	48x64x80	4.5x	36x48x60	6x	27x36x45	7.9x
0.2x	48x64x80	4.6x	33x44x55	6.6x	24x32x40	9x	18x24x30	12x	13.5x18x22.5	15.8x
0.3x	32x42.67x53.33	6.9x	22x29.33x36.67	9.9x	16x21.33x26.67	13.5x	12x16x20	18x	9x12x15	23.7x
0.4x	24x32x40	9.2x	16.5x22x27.5	13.2x	12x16x20	18x	9x12x15	24x	6.75x9x11.25	31.6x
0.5x	19.2x25.6x32	11.5x	13.2x17.6x22	16.5x	9.6x12.8x16	22.5x	7.2x9.6x12	30x	5.4x7.2x9	39.5x
0.6x	16x21.33x26.67	13.8x	11x14.67x18.33	19.8x	8x10.67x13.33	27x	6x8x10	36x	4.5x6x7.5	47.4x
0.7x	13.71x18.29x22.86	16.1x	9.43x12.57x15.71	23.1x	6.86x9.14x11.43	31.5x	5.14x6.86x8.57	42x	3.86x5.14x6.43	55.3x
0.8x	12x16x20	18.4x	8.25x11x13.75	26.4x	6x8x10	36x	4.5x6x7.5	48x	3.38x4.5x5.63	63.2x
0.9x	10.67x14.22x17.78	20.7x	7.33x9.78x12.22	29.7x	5.33x7.11x8.89	40.5x	4x5.33x6.67	54x	3x4x5	71.1x
1x	9.6x12.8x16.0	23x	6.6x8.8x11	33x	4.8x6.4x8.0	45x	3.6x4.8x6.0	60x	2.7x3.6x4.5	79x
2x	4.8x6.4x8.0	46x	3.3x4.4x5.5	66x	2.4x3.2x4.0	90x	1.8x2.4x3.0	120x	1.35x1.8x2.25	158x
3x	3.2x4.27x5.33	69x	2.2x2.93x3.67	99x	1.6x2.3x2.67	135x	1.2x1.6x2.0	180x	0.9x1.2x1.5	237x
4x	2.4x3.2x4.0	92x	1.65x2.2x2.75	132x	1.2x1.6x2.0	18x	0.9x1.2x1.5	240x	0.68x0.9x1.13	316x
5x	1.92x2.56x3.2	115x	1.32x1.76x2.2	165x	0.96x1.28x1.6	225x	0.72x0.96x1.2	300x	0.54x0.72x0.9	395x
6x	1.6x2.13x2.67	138x	1.1x1.47x1.83	198x	0.8x1.07x1.33	27x	0.6x0.8x1.0	360x	0.45x0.6x0.75	474x
7x	1.37x1.83x2.29	161x	0.94x1.26x1.57	231x	0.69x0.91x1.14	315x	0.51x0.69x0.86	420x	0.39x0.51x0.64	553x
8x	1.2x1.6x2.0	184x	0.83x1.1x1.38	264x	0.6x0.8x1.0	36x	0.45x0.6x0.75	480x	0.34x0.45x0.56	632x
9x	1.07x1.42x1.78	207x	0.73x0.98x1.22	297x	0.53x0.71x0.89	405x	0.4x0.53x0.67	540x	0.3x0.4x0.5	711x
10x	0.96x1.28x1.6	230x	0.66x0.88x1.1	330x	0.48x0.64x0.8	450x	0.36x0.48x0.6	600x	0.27x0.36x0.45	790x