

CH12M2524S117

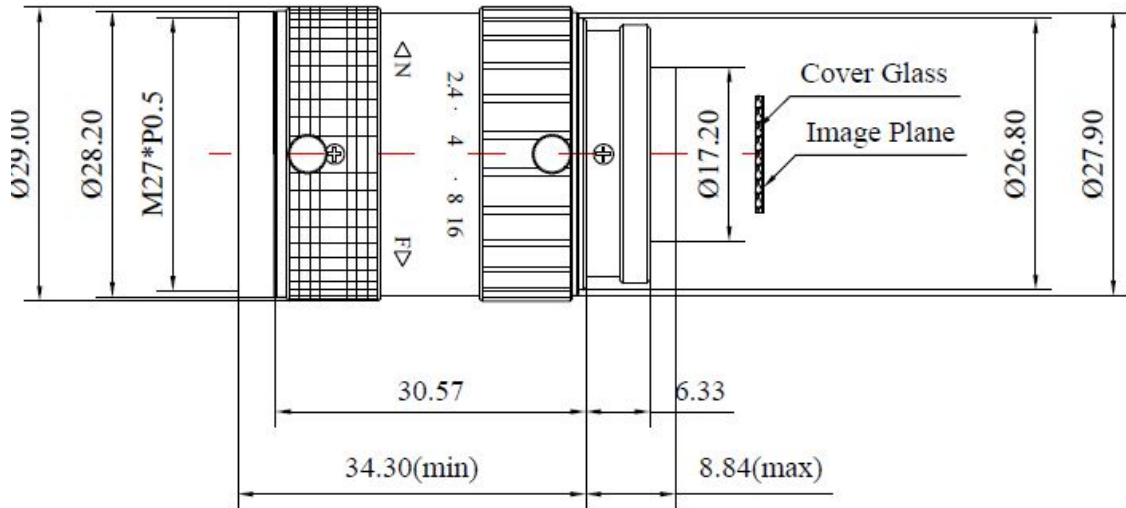

The C-Mount lens Lensagon CH12M2524S117 is suitable for current sensors up to 12.00 megapixel with an image format of 1/1.7 inch.

Technical Data

Mount	C-Mount
Sensor	1/1.7 inch
Focal Length	25.00 mm
Aperture	2.40
MOD	0.10 m
Back Focal	17.53 mm
Angle of View	D:21.20° H:16.80° V:12.80°
Megapixel	12.00 MP
TV Distortion	0.10 %
Typ	Standard